



# **Agilent U1461A Insulation Multimeter/ U1453A Insulation Tester**

## **User's Guide**



**Agilent Technologies**

# Notices

© Agilent Technologies, Inc. 2014

No part of this manual may be reproduced in any form or by any means (including electronic storage and retrieval or translation into a foreign language) without prior agreement and written consent from Agilent Technologies, Inc. as governed by United States and international copyright laws.

## Manual Part Number

U1461-90003

## Edition

Third Edition, June 26, 2014

Agilent Technologies, Inc.  
5301 Stevens Creek Blvd.  
Santa Clara, CA 95051 USA

## Warranty

**The material contained in this document is provided “as is,” and is subject to being changed, without notice, in future editions. Further, to the maximum extent permitted by applicable law, Agilent disclaims all warranties, either express or implied, with regard to this manual and any information contained herein, including but not limited to the implied warranties of merchantability and fitness for a particular purpose. Agilent shall not be liable for errors or for incidental or consequential damages in connection with the furnishing, use, or performance of this document or of any information contained herein. Should Agilent and the user have a separate written agreement with warranty terms covering the material in this document that conflict with these terms, the warranty terms in the separate agreement shall control.**

## Technology Licenses

The hardware and or software described in this document are furnished under a license and may be used or copied only in accordance with the terms of such license.

## Restricted Rights Legend

U.S. Government Restricted Rights. Software and technical data rights granted to the federal government include only those rights customarily provided to end user customers. Agilent provides this customary commercial license in Software and technical data pursuant to FAR 12.211 (Technical Data) and 12.212 (Computer Software) and, for the Department of Defense, DFARS 252.227-7015 (Technical Data - Commercial Items) and DFARS 227.7202-3 (Rights in Commercial Computer Software or Computer Software Documentation).

## Safety Notices

### CAUTION

A **CAUTION** notice denotes a hazard. It calls attention to an operating procedure, practice, or the like that, if not correctly performed or adhered to, could result in damage to the product or loss of important data. Do not proceed beyond a **CAUTION** notice until the indicated conditions are fully understood and met.

---









### WARNING

A **WARNING** notice denotes a hazard. It calls attention to an operating procedure, practice, or the like that, if not correctly performed or adhered to, could result in personal injury or death. Do not proceed beyond a **WARNING** notice until the indicated conditions are fully understood and met.

---

## Safety Symbols

The following symbols on the instrument and in the documentation indicate precautions which must be taken to maintain safe operation of the instrument.

	Direct current (DC)		Caution, risk of electric shock
	Alternating current (AC)		Caution, risk of danger (refer to this manual for specific Warning or Caution information)
	Both direct and alternating current	<b>CAT III 1000 V</b>	Category III 1000 V overvoltage protection
	Earth (ground) terminal	<b>CAT IV 600 V</b>	Category IV 600 V overvoltage protection
	Equipment protected throughout by double insulation or reinforced insulation		Do not use in distribution systems with voltages higher than 600 V

## Safety Considerations

Read the information below before using this tester. The descriptions and instructions in this manual apply to the Agilent U1461A Insulation Multimeter and the U1453A Insulation Tester.

Model U1461A appears in all illustrations. The word *tester* is used to represent both models.

### WARNING

- **Do not exceed any of the measurement limits defined in the specifications to avoid instrument damage and the risk of electric shock.**
- **Do not use the tester if it is damaged. Before you use the tester, inspect the case. Look for cracks or missing plastic. Pay particular attention to the insulation surrounding the connectors.**
- **Inspect the test leads for damaged insulation or exposed metal. Check the test leads for continuity. Replace damaged test leads before you use the tester.**
- **Do not operate the tester around explosive gas, vapor, or wet environments.**
- **Do not apply more than the rated voltage (as marked on the tester) between terminals, or between terminal and earth ground.**
- **Before use, verify the tester's operation by measuring a known voltage.**
- **When servicing the tester, use only the specified replacement parts.**
- **Use caution when working above 60 VDC, 30 VAC RMS, or 42.4 V peak. Such voltages pose a shock hazard.**
- **When using the probes, keep your fingers behind the finger guards on the probes.**
- **Connect the common test lead before you connect the live test lead. When you disconnect the leads, disconnect the live test lead first.**
- **Remove the test leads from the tester before you open the battery cover.**
- **Do not operate the tester with the battery cover or portions of the cover removed or loosened.**
- **To avoid false readings, which may lead to possible electric shock or personal injury, replace the battery as soon as the low battery indicator appears and flashes.**

## WARNING

- **Ensure that you do not perform insulation resistance tests in distribution systems with voltages higher than 600 V.**
- **For insulation resistance tests, ensure that you select a suitable test voltage for the equipment to be tested.**

**For model U1461A only:**

- **When measuring current, turn off the circuit power before connecting the tester in the circuit. Remember to place the tester in series with the circuit.**
  - **Be aware of the presence of hazardous voltage before using the Low Pass Filter (LPF) function for voltage measurement. Voltages measured are usually greater than the values indicated on the tester as the voltages with higher frequencies have been filtered through the LPF function.**
- 

## CAUTION

- Disconnect circuit power and discharge all high-voltage capacitors before testing resistance, continuity, diodes, or capacitance.
- Use the proper terminals, function, and range for your measurements.
- This device is for use at altitudes of up to 2,000 m.
- Always use the specified battery type. The power for the tester is supplied with four 1.5 V AA batteries. Observe the correct polarity markings before you insert the batteries to ensure proper insertion of the batteries in the tester.

**For model U1461A only:**

- Never measure voltage when current measurement is selected.
-

## Environmental Conditions

This instrument is designed for indoor use and in an area with low condensation. The table below shows the general environmental requirements for this instrument.

Environmental condition	Requirement
Temperature	<ul style="list-style-type: none"><li>• <b>Operating condition</b><ul style="list-style-type: none"><li>• –40 °C to 55 °C, 0% to 80% RH (using lithium batteries), &gt;1 hour operating time<sup>[1]</sup></li><li>• –20 °C to 55 °C, 0% to 80% RH (using alkaline batteries), 20 minutes operating time<sup>[1]</sup></li></ul></li><li>• <b>Storage condition</b><ul style="list-style-type: none"><li>• –40 °C to 70 °C, 0% to 80% RH (without batteries)</li></ul></li></ul>
Humidity	Full accuracy up to 80% RH for temperatures up to 30 °C, decreasing linearly to 50% RH at 55 °C
Altitude	Up to 2,000 meters
Pollution degree	Pollution degree II





[1] The operating time is defined when the tester stays at a temperature of 20°C, and then it is moved to colder environment of –40°C for short period of time. The operating temperature of the battery should be allowed from –20°C or –40°C. You should monitor the ambient temperature sensed by the tester. The tester is operational if the temperature display is no less than –20°C or –40°C, according to battery type.

### NOTE

The U1461A Insulation Multimeter and U1453A Insulation Tester complies with the following safety and EMC requirements:

- **Safety compliance**
  - Designed in compliance to IEC/EN 61010-1:2010 for Category III 1000 V and Category IV 600 V
  - Designed in compliance to IEC/EN 61557-1, IEC/EN 61557-2, and IEC/EN 61557-4
- **EMC compliance**
  - Commercial limits compliance with IEC 61326-1:2005/EN 61326-1:2006

## Regulatory Markings

	<p>The CE mark is a registered trademark of the European Community. This CE mark shows that the product complies with all the relevant European Legal Directives.</p>		<p>The C-tick mark is a registered trademark of the Spectrum Management Agency of Australia. This signifies compliance with the Australia EMC Framework regulations under the terms of the Radio Communication Act of 1992.</p>
<p><b>ICES/NMB-001</b></p>	<p>ICES/NMB-001 indicates that this ISM device complies with the Canadian ICES-001. Cet appareil ISM est conforme a la norme NMB-001 du Canada.</p>		<p>This instrument complies with the WEEE Directive (2002/96/EC) marking requirement. This affixed product label indicates that you must not discard this electrical or electronic product in domestic household waste.</p>
	<p>The CSA mark is a registered trademark of the Canadian Standards Association.</p>		<p>This symbol indicates the time period during which no hazardous or toxic substance elements are expected to leak or deteriorate during normal use. Forty years is the expected useful life of the product.</p>

## Waste Electrical and Electronic Equipment (WEEE) Directive 2002/96/EC

This instrument complies with the WEEE Directive (2002/96/EC) marking requirement. This affixed product label indicates that you must not discard this electrical or electronic product in domestic household waste.

### Product Category:

With reference to the equipment types in the WEEE directive Annex 1, this instrument is classified as a “Monitoring and Control Instrument” product.

The affixed product label is as shown below.



### Do not dispose in domestic household waste.

To return this unwanted instrument, contact your nearest Agilent Service Center, or visit

[www.agilent.com/environment/product](http://www.agilent.com/environment/product)

for more information.



## Declaration of Conformity (DoC)

The Declaration of Conformity (DoC) for this instrument is available on the Agilent Web site. You can search the DoC by its product model or description at:

<http://regulations.corporate.agilent.com/DoC/search.htm>

### NOTE

If you are unable to search for the respective DoC, please contact your local Agilent representative.

---

**THIS PAGE HAS BEEN INTENTIONALLY LEFT BLANK.**

# Table of Contents

## 1 Introduction

About This Manual	2
Documentation map	2
Safety notes	2
Preparing Your Tester	3
Check the shipment	3
Install or change the batteries	3
Turn on your tester	6
Select the range	6
Adjust the tilt stand	7
Connect to the Handheld Meter Logger Software	8
Connect the Bluetooth adapter	9
Your Tester in Brief	10
Dimensions	10
Overview	12
Rotary switch	14
Keypad	17
Display screen	21
Input terminals	29
Cleaning Your Tester	30
Additional Features	31
Automatic power-off	31
OLED Auto Dim function	31
Change the OLED brightness	31
Hazardous voltage indication	32
Power-on options	32

## 2 Making Measurements

Insulation Resistance Test	36
Using the Remote Switch Probe	38
Locking the test	39
Timed (T) insulation resistance/earth-bond resistance test	40
Measuring the Dielectric Absorption Ratio (DAR)	41
Measuring the Polarization Index (PI)	42
Viewing the leakage current	43
Performing leakage current trip tests	43
Performing stepped voltage trip tests	45
Changing the insulation resistance test voltage	50
Earth-Bond Resistance Test	51
Measuring AC or DC Voltage	54
Auto AC or DC signal identification	56
Using the LPF (Low Pass Filter) feature for AC signals	57
Enabling the LPF in the Setup	59
Measuring AC or DC Current	60
% Scale of 4-20 mA or 0-20 mA	62
Measuring Frequency	63
Measuring duty cycle and pulse width	65
Measuring Resistance	66
Continuity Test	68
Diode Test	70
Using the Auto-diode feature	73
Measuring Capacitance	75
Viewing the cable length value	77
Measuring Temperature	78

### **3 Tester Features**

Non-Contact AC Voltage Detection (Vsense)	84
Making Relative Measurements (Null)	86
Capturing Maximum and Minimum Values (Max Min)	87
Freezing the Display (TrigHold and AutoHold)	89
Performing Limit Comparisons (Limit)	90
Recording Measurement Data (Log)	92
Performing manual logs (HAND)	93
Performing interval logs (AUTO)	93
Performing event logs (TRIG)	94
Reviewing Previously Recorded Data (View)	97

### **4 Setup Options**

Using the Setup Menu	100
Editing numerical values	101
Setup Menu Summary	102
Setup Menu Items	109
Menu 1	109
Menu 2	113
Menu 3	115
Menu 4	119
Menu 5	123
Menu 6	125
Menu 7	129
Menu 8	133
Menu 9	134
Menu 10	138

## **5 Characteristics and Specifications**

Product Characteristics	144
Specification Considerations	146
Measurement Category	146
Electrical Specifications	147
DC specifications	147
AC specifications	150
Capacitance specifications	152
Temperature specifications	153
Frequency specifications	154
Duty cycle and pulse width specifications (model U1461A only)	155
Frequency sensitivity specifications	157
Insulation resistance specifications	159
Earth-bond resistance specifications	161
Adjustable DC test voltage specifications	161
EN61557 specifications	162
Display update rate (approximate)	163

## List of Figures

Figure 1-1	Agilent Handheld Meter Logger Software	8
Figure 1-2	Bluetooth adapter connection	9
Figure 1-3	Width dimensions	10
Figure 1-4	Height and depth dimensions	11
Figure 1-5	Display screen allocation example	21
Figure 1-6	Analog bar graph example	27
Figure 1-7	Connecting the remote switch probe	29
Figure 2-1	Insulation resistance test example	37
Figure 2-2	T operation	40
Figure 2-3	DAR operation	41
Figure 2-4	PI operation	42
Figure 2-5	TRIP operation	44
Figure 2-6	Scan signal	46
Figure 2-7	SCAN TRIP operation	47
Figure 2-8	Ramp signal	48
Figure 2-9	RAMP TRIP operation	49
Figure 2-10	Earth-bond resistance test example	52
Figure 2-11	AC or DC voltage measurement example	55
Figure 2-12	AC voltage with LPF measurement example	57
Figure 2-13	Enabling the low-pass filter	59
Figure 2-14	AC or DC current measurement example	61
Figure 2-15	Definition of frequency	64
Figure 2-16	Resistance measurement example	67
Figure 2-17	Continuity test example	69
Figure 2-18	Forward-bias diode test example	71
Figure 2-19	Reverse-bias diode test example	72
Figure 2-20	Auto-diode operation	74
Figure 2-21	Capacitance measurement example	76
Figure 2-22	Surface temperature measurement example	80
Figure 3-1	Detecting AC voltage example	85

**THIS PAGE HAS BEEN INTENTIONALLY LEFT BLANK.**



## List of Tables

Table 1-1	Front panel part descriptions	12
Table 1-2	Rear panel parts	13
Table 1-3	U1461A/U1453A rotary switch functions	14
Table 1-4	U1461A/U1453A keypad functions	17
Table 1-5	General annunciators	22
Table 1-6	Measurement units display	26
Table 1-7	Analog bar graph display counts/bar	28
Table 1-8	Terminal connections for different measuring functions	29
Table 1-9	Power-on options	32
Table 2-1	Rotary switch position for insulation resistance tests	36
Table 2-2	User test voltage range for insulation resistance	50
Table 2-3	Earth-bond resistance test position	51
Table 2-4	AC and DC voltage measurement positions	54
Table 2-5	AC and DC current measurement positions	60
Table 2-6	% Scale measurement range	62
Table 2-7	Measurement positions allowing frequency measurements	63
Table 2-8	Resistance measurement position	66
Table 2-9	Continuity test position	68
Table 2-10	Diode test position	70
Table 2-11	Auto-diode voltage thresholds	73
Table 2-12	Capacitance measurement position	75
Table 2-13	Temperature measurement position	78
Table 3-1	Hi/Lo default settling values	90
Table 3-2	Log maximum capacity	92
Table 3-3	Event log trigger conditions	95
Table 4-1	Setup menu key functions	100
Table 4-2	Setup menu item descriptions	102
Table 5-1	DC voltage specifications with accuracy of $\pm$ (% of reading + no. of least significant digit)	147
Table 5-2	Resistance/Audible continuity specifications with accuracy of $\pm$ (% of reading + no. of least significant digit)	148

<b>Table 5-3</b>	Diode specifications with accuracy of $\pm$ (% of reading + no. of least significant digit) <b>148</b>
<b>Table 5-4</b>	DC current specifications with accuracy of $\pm$ (% of reading + no. of least significant digit) (model U1461A only) <b>149</b>
<b>Table 5-5</b>	True RMS AC voltage specifications with accuracy of $\pm$ (% of reading + no. of least significant digit) <b>150</b>
<b>Table 5-6</b>	True RMS AC current specifications with accuracy of $\pm$ (% of reading + no. of least significant digit) (model U1461A only) <b>151</b>
<b>Table 5-7</b>	Capacitance specifications with accuracy of $\pm$ (% of reading + no. of least significant digit) <sup>[1][2]</sup> <b>152</b>
<b>Table 5-8</b>	Temperature specifications with accuracy of $\pm$ (% of reading + offset error) <sup>[1]</sup> <b>153</b>
<b>Table 5-9</b>	Frequency specifications with accuracy of $\pm$ (% of reading + no. of least significant digit) <sup>[1][2]</sup> <b>154</b>
<b>Table 5-10</b>	Duty cycle and pulse width specifications with accuracy of $\pm$ (% of reading + no. of least significant digit) <sup>[2]</sup> <b>155</b>
<b>Table 5-11</b>	Duty cycle and pulse width calculation example <b>156</b>
<b>Table 5-12</b>	Frequency sensitivity and trigger level specifications for voltage measurements <b>157</b>
<b>Table 5-13</b>	Frequency sensitivity specifications for current measurements <b>158</b>
<b>Table 5-14</b>	Insulation resistance specifications with accuracy of $\pm$ (% of reading + no. of least significant digit) <b>159</b>
<b>Table 5-15</b>	Earth-bond resistance specifications with accuracy of $\pm$ (% of reading + no. of least significant digit) <sup>[1]</sup> <b>161</b>
<b>Table 5-16</b>	Adjustable DC test voltage specifications with accuracy of $\pm$ (% of reading + no. of least significant digit) <sup>[1][2]</sup> <b>161</b>
<b>Table 5-17</b>	Display update rate (approximate) <b>163</b>



# 1 Introduction

About This Manual	2
Documentation map	2
Safety notes	2
Preparing Your Tester	3
Check the shipment	3
Install or change the batteries	3
Turn on your tester	6
Select the range	6
Adjust the tilt stand	7
Connect to the Handheld Meter Logger Software	8
Connect the Bluetooth adapter	9
Your Tester in Brief	10
Dimensions	10
Overview	12
Rotary switch	14
Keypad	17
Display screen	21
Input terminals	29
Cleaning Your Tester	30
Additional Features	31
Automatic power-off	31
OLED Auto Dim function	31
Change the OLED brightness	31
Hazardous voltage indication	32
Power-on options	32

This chapter helps you set up your tester for the first time. An introduction to all the features of the tester is also given.



## About This Manual

### Documentation map

The following manuals and software related to the *U1461A Insulation Multimeter* and the *U1453A Insulation Tester* are available for download. Please visit our website at <http://www.agilent.com/find/hhTechLib> for the latest version.

Check the manual edition on the first page of each manual.

**User's Guide.** This manual.

**Quick Start Guide.** Printed copy for outdoor use, included with shipment.

**Service Guide.** Downloadable from <http://www.agilent.com/find/hhTechLib>

**Agilent Handheld Meter Logger Software, Help, and Quick Start Guide.** Downloadable from <http://www.agilent.com/hhmeterlogger>

### Safety notes

The following safety notes are used throughout this manual. More pertinent safety notes for using this product are located under the “[Safety Symbols](#)” section.

#### CAUTION

Caution denotes a hazard. It calls attention to a procedure that, if not correctly performed or adhered to, could result in damage to or destruction of the product. Do not proceed beyond a caution notice until the indicated conditions are fully understood and met.

---

#### WARNING

Warning denotes a hazard. It calls attention to a procedure which, if not correctly performed or adhered to, could result in injury or loss of life. Do not proceed beyond a warning note until the indicated conditions are fully understood and met.

---

# Preparing Your Tester

## Check the shipment

When you receive your tester, check the shipment according to the following procedure.

- 1 Inspect the shipping container for damage. Signs of damage may include a dented or torn shipping container or cushioning material that indicates signs of unusual stress or compacting. Save the packaging material in case the tester needs to be returned.
- 2 Carefully remove the contents from the shipping container, and verify that the standard accessories and your ordered options are included in the shipment according to the standard shipped items list found in the printed copy of the *U1461A/U1453A Quick Start Guide*.
- 3 For any question or problems, refer to the Agilent contact numbers on the back of this manual.

## Install or change the batteries

Your tester is powered by four 1.5 V AA lithium batteries (included in the shipment). When you receive your tester, the batteries are not installed.

Use the following procedure to install or change the batteries.

### CAUTION

Before you proceed with the batteries installation, remove all cable connections to the terminals and ensure that the rotary switch is at the **OFF** position. Use only the battery type specified in the “[Product Characteristics](#)” on page 144.

---

## 1 Introduction

### Preparing Your Tester

- 1 Remove the orange rubber holster. Pull from a top corner and stretch the orange rubber holster off the tester.
- 2 Loosen and remove the two screws with a suitable Phillips screwdriver as shown on the right.

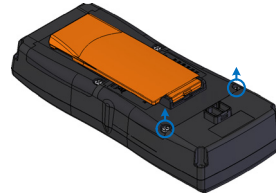

- 3 Lift and remove the battery cover as shown on the left.

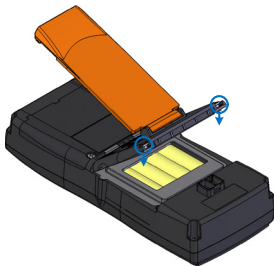
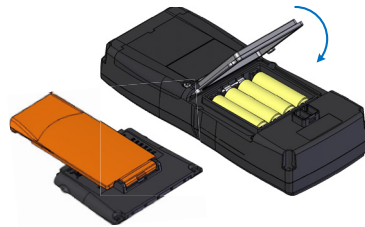

- 4 Lift the inner rubber cover to access the battery compartment.
- 5 Observe the proper battery polarity. The terminal ends of each battery are indicated inside the battery compartment. Insert four 1.5 V AA batteries.



- 6 Ensure that the inner rubber cover is positioned properly.
- 7 Replace the battery cover back in its original position and tighten the screws.
- 8 Finally fit the orange rubber holster back on the tester.

The battery level indicator in the upper left-hand corner of the display indicates the relative condition of the batteries.



Replace the batteries as soon as possible when the low battery indicator (  ↔  ) flashes.

**WARNING**

To avoid false readings, which could lead to possible electric shock or personal injury, replace the battery as soon as the low battery indicator appears. Do not discharge the battery by shorting the battery or reversing the battery polarity in any of the batteries.

**CAUTION**

To avoid testers being damaged from battery leakage:

- Always remove dead batteries immediately.
- Always remove the batteries and store them separately if the tester is not going to be used for a long period.

## Turn on your tester

To power ON your tester, turn the rotary switch from the **OFF** position to any other position.

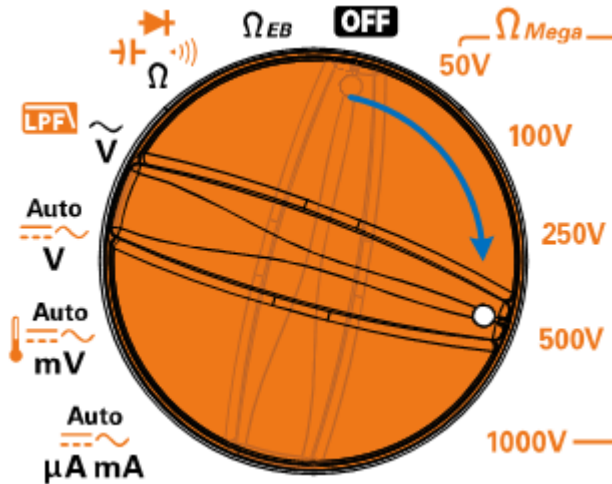

## Select the range

The tester's selected range is always displayed on the right-hand end of the bar graph.





Pressing **Range** changes the tester range (and disables auto-ranging). Each additional presses of **Range** (in manual ranging) sets the tester to the next higher range, unless it is already in the highest range, at which point the range switches to the lowest range.

Press and hold **Range** to switch the tester to **auto-ranging**. Auto-ranging is convenient because the tester automatically selects an appropriate range for sensing and displaying each measurement.

**NOTE**

- Changing the tester range (and disabling auto-ranging) is not allowed for earth-bond resistance tests and insulation resistance tests.
- The range is fixed for diode tests and temperature measurements.
- In auto-range, the tester selects the lowest range to display the highest available precision (resolution) for the input signal.
- If a reading is greater than maximum available range, **OL** (overload) is shown on the display — except for earth-bond resistance tests and insulation resistance tests where **>** is shown on the display instead.

## Adjust the tilt stand

To adjust the tester to a 60° standing position, pull the tilt-stand outward to its maximum reach.

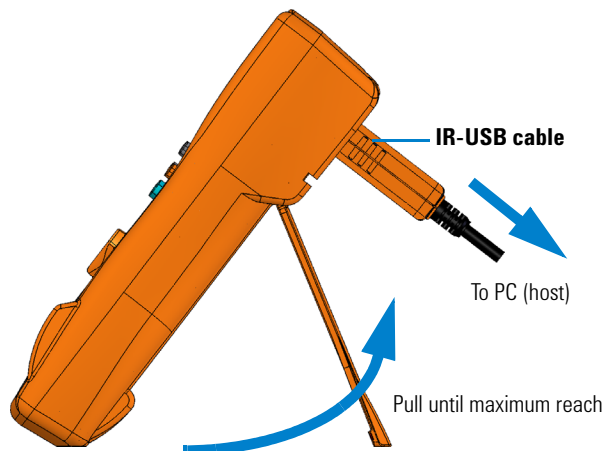

## Connect to the Handheld Meter Logger Software

You can use the IR communication link (IR communication port, located at the rear panel) and the Agilent Handheld Meter Logger Software to control your tester remotely, perform data logging operations, and transfer the contents of your tester's memory to a PC.

Ensure that the Agilent logo on the U1173A IR-USB cable connected to the tester is facing up. Firmly push the IR head into the tester's IR communication port until it snaps into place.

Refer to the *Agilent Handheld Meter Logger Software Help* and *Quick Start Guide* for more information on the IR communication link and the Agilent Handheld Meter Logger Software.

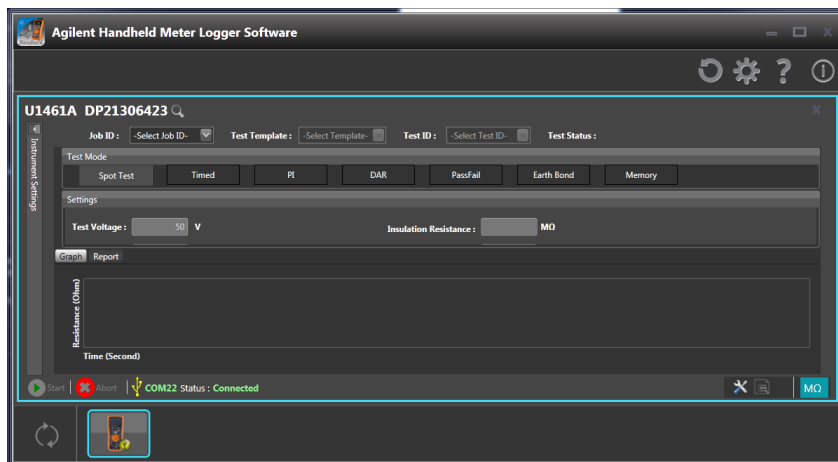

**Figure 1-1** Agilent Handheld Meter Logger Software

The Agilent Handheld Meter Logger Software and its supporting documents (Quick Start Guide and Help) are available for download from <http://www.agilent.com/hhmeterlogger>.

## Connect the Bluetooth adapter

The U1117A Infrared (IR)-to-**Bluetooth**® adapter allows you to connect the tester wirelessly to any Windows PC, Android device, or iOS device.

The U1117A is compatible with the following application or software:

- Agilent Handheld Meter Logger (for Windows PC)
- Agilent Mobile Meter (for Android or iOS devices)
- Agilent Mobile Logger (for Android or iOS devices)

Snap the optic side of the U1117A to the tester's IR communication port (see [Figure 1-2](#)).

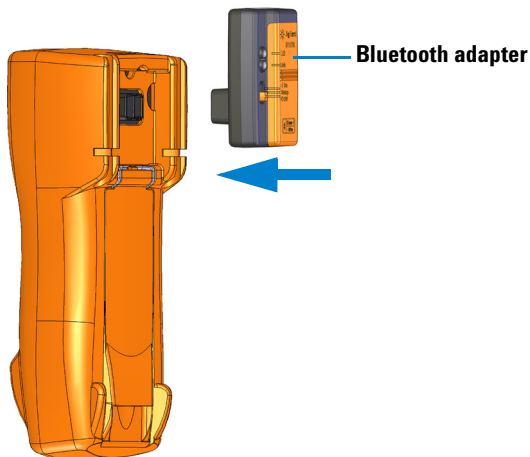

**Figure 1-2** Bluetooth adapter connection

Refer to the *Agilent U1117A IR- to- Bluetooth Adapter Operating Instructions* (download from <http://www.agilent.com/find/U1117A>) for more information on how to set up the U1117A to a Windows PC, Android device, or iOS device.

# Your Tester in Brief

## Dimensions

Front view



Figure 1-3 Width dimensions

**Rear and side view**

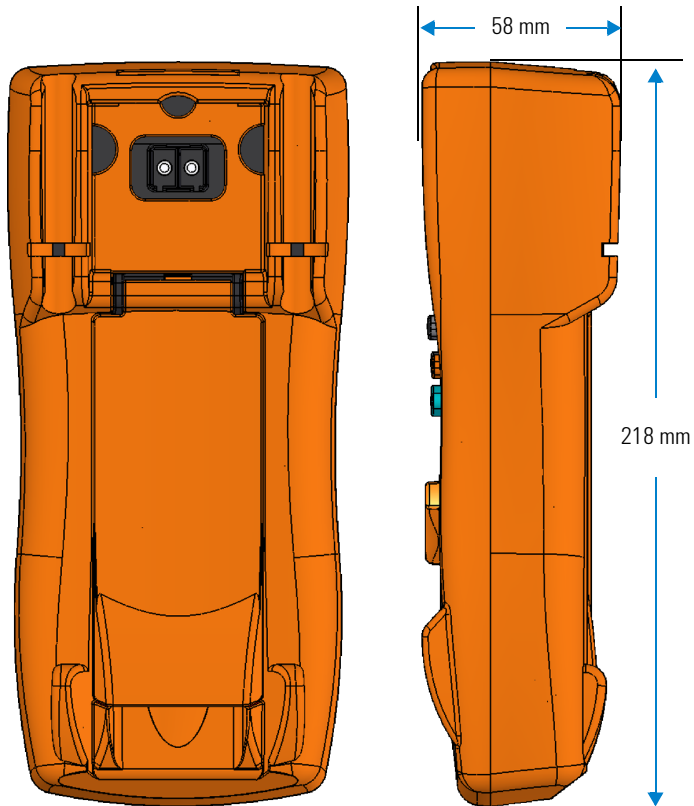
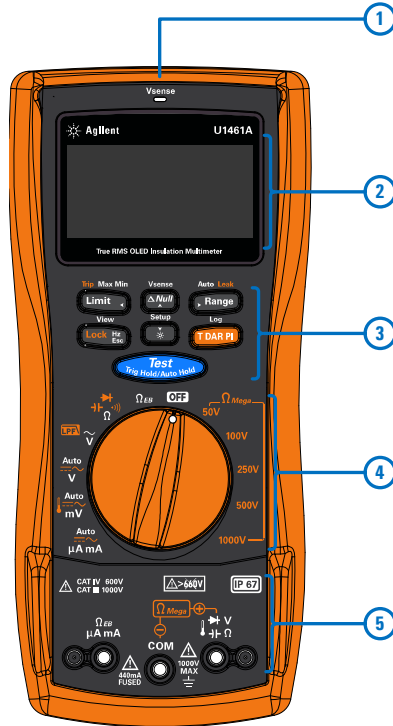

**Figure 1-4** Height and depth dimensions

## Overview

### Front panel

The front panel parts of your tester are described in this section.

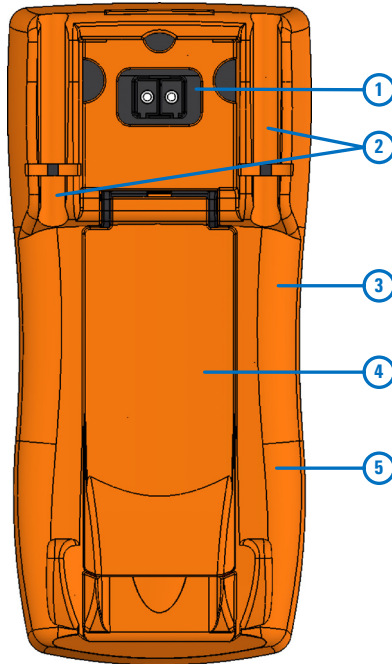

**Table 1-1** Front panel part descriptions

Legend	Description	Learn more on:
1	Vsense detector (model U1461A only)/Red LED indicator	<a href="#">page 84</a>
2	Display screen	<a href="#">page 21</a>
3	Keypad	<a href="#">page 17</a>
4	Rotary switch	<a href="#">page 14</a>
5	Input terminals	<a href="#">page 29</a>

## Rear panel

The rear panel parts of your tester are described in this section.



**Table 1-2** Rear panel parts

Legend	Description	Learn more on:
1	IR communication port	<a href="#">page 8</a>
2	Test lead/probe holders	-
3	Battery access (under the orange rubber holster)	<a href="#">page 3</a>
4	Tilt stand	<a href="#">page 7</a>
5	Fuse access (under the orange rubber holster)	-

## Rotary switch

The measurement functions for each rotary switch position are described in [Table 1-3](#). Turning the rotary switch changes the measurement function and resets all other measurement options.

### WARNING

Remove the test leads from the measuring source or target before changing the rotary switch position.

### NOTE

Press **T/DAR/PI** to select the alternate measurement function(s) or test methods for insulation resistance tests. See [page 17](#) for more information on the **T/DAR/PI** key.

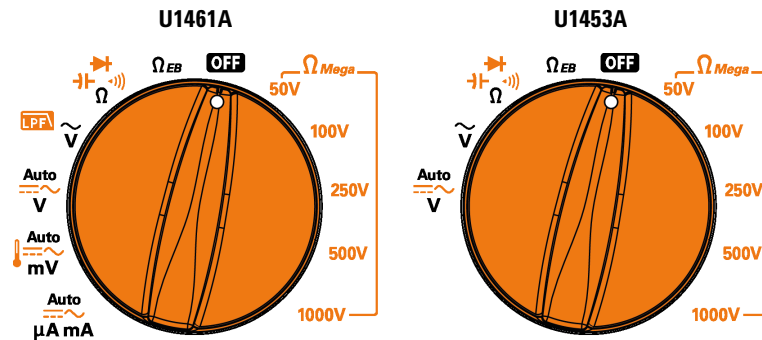

**Table 1-3** U1461A/U1453A rotary switch functions





Legend	Measurement function	U1461A	U1453A	Learn more on:
	50 V Insulation resistance test	✓	✓	
Ω Mega 50V	T - Timed test	✓	✓	page 51
	DAR - Dielectric Absorption Ratio test	✓	✓	
	PI - Polarization Index Test	✓	✓	



**Table 1-3** U1461A/U1453A rotary switch functions (continued)

<b>Legend</b>	<b>Measurement function</b>	<b>U1461A</b>	<b>U1453A</b>	<b>Learn more on:</b>
	100 V Insulation resistance test	✓	✓	page 51
	T - Timed test	✓	✓	
	DAR - Dielectric Absorption Ratio test	✓	✓	
	PI - Polarization Index Test	✓	✓	
	250 V Insulation resistance test	✓	✓	page 51
	T - Timed test	✓	✓	
	DAR - Dielectric Absorption Ratio test	✓	✓	
	PI - Polarization Index Test	✓	✓	
	500 V Insulation resistance test	✓	✓	page 51
	T - Timed test	✓	✓	
	DAR - Dielectric Absorption Ratio test	✓	✓	
	PI - Polarization Index Test	✓	✓	
	1000 V Insulation resistance test	✓	✓	page 51
	T - Timed test	✓	✓	
	DAR - Dielectric Absorption Ratio test	✓	✓	
	PI - Polarization Index Test	✓	✓	
	Earth-bond resistance test	✓	✓	page 51
	T - Timed test	✓	✓	
	Resistance measurement	✓	✓	page 66
	Continuity test	✓	✓	page 68
	Diode test	✓	✓	page 70
	Capacitance measurement	✓	✓	page 75

**Table 1-3** U1461A/U1453A rotary switch functions (continued)

Legend	Measurement function	U1461A	U1453A	Learn more on:
	AC voltage measurement	✓	✓	<a href="#">page 36</a>
	AC voltage measurement with Low Pass Filter (LPF)	✓	-	<a href="#">page 57</a>
	Auto voltage measurement	✓	✓	<a href="#">page 36</a>
	DC voltage measurement	✓	✓	
	AC voltage measurement	✓	✓	
	Auto voltage measurement (mV)	✓	-	<a href="#">page 78</a>
	DC voltage measurement (mV)	✓	-	
	AC voltage measurement (mV)	✓	-	
	Temperature measurement	✓	-	<a href="#">page 60</a>
	Auto current measurement (μA mA)	✓	-	
	DC current measurement (μA mA)	✓	-	
	AC current measurement (μA mA)	✓	-	
	% Scale of 4-20 mA	✓	-	

## Keypad

The operation of each key is explained in Table 1-4 below. Pressing a key enables a function, displays a related symbol, and emits a beep. Turning the rotary switch to another position resets the current operation of the key.

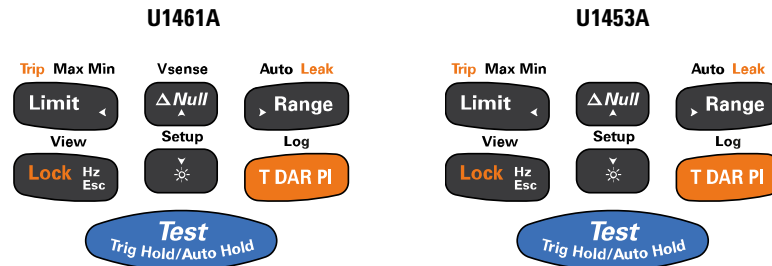

















































Table 1-4 U1461A/U1453A keypad functions

Legend	Function when pressed for:	
	Less than 1 second	More than 1 second
	<p><b>Insulation Resistance (IR) Test:</b> Initiates an IR test (when the rotary switch is in one of the <math>\Omega</math> Mega positions) as long as  is held — the tester sources (outputs) a high voltage and measures insulation resistance and  is shown on the display.</p>	
	<p><b>Earth-Bond Resistance (EBR) Test:</b> Initiates an EBR test (when the rotary switch is in the <math>\Omega</math> EB position) as long as  is held — the tester measures earth-bond resistance and  is shown on the display.</p>	
	<p><b>Trig Hold:</b> Freezes the present reading in the display (except when the rotary switch is in one of the <math>\Omega</math> Mega positions or in the <math>\Omega</math> EB position).</p> <ul style="list-style-type: none"> <li>In TrigHold mode, press  to manually trigger the holding of the next measured value.</li> <li>Press and hold  again to exit this mode.</li> </ul>	<p><b>Auto Hold:</b> Automatically freezes the present reading once the reading is stable (except when the rotary switch is in one of the <math>\Omega</math> Mega positions or in the <math>\Omega</math> EB position).</p> <ul style="list-style-type: none"> <li>In AutoHold mode, the reading is updated automatically once the reading is stable and the count setting is exceeded.</li> <li>Press and hold  again to exit this mode.</li> </ul>



























**Table 1-4** U1461A/U1453A keypad functions (continued)

Legend	Function when pressed for:	
	Less than 1 second	More than 1 second
<p>View</p> 	<p><b>Lock:</b> Press  to lock the insulation test or earth-bond resistance test (when the rotary switch is in the appropriate position).</p> <ul style="list-style-type: none"> <li>Press  &gt;  to initiate an IR or EBR test. The test remains active until you press  or  again to release the lock.</li> <li>Press  during capacitance measurements to view the cable length of the circuit under test.</li> </ul> <p><b>HZ:</b> Press  to display the frequency for voltage or current measurements.</p> <ul style="list-style-type: none"> <li><b>Model U1461A only:</b> Press  again to scroll through the frequency (Hz), pulse width (ms), and duty cycle (%) measurements. This option must first be enabled in the Setup menu (see <a href="#">page 141</a>).</li> <li>Press  again to disable the frequency display.</li> </ul> <p><b>Esc:</b> Press  in the Setup menu to discard your changes.</p>	<p><b>View:</b> Press and hold  to enter the Log Review menu.</p> <ul style="list-style-type: none"> <li>Press  to cycle through the previously recorded manual (<b>VIEW H</b>), interval (<b>VIEW A</b>), or event (<b>VIEW E</b>) logging data.</li> <li>Press  or  to view first or last logged data respectively.</li> <li>Press  or  to scroll through the logged data.</li> <li>Press  to delete the last logged data.</li> <li>Press and hold  to clear all the logged data for the selected logging mode.</li> <li>Press and hold  again to exit this mode.</li> </ul>

**Table 1-4** U1461A/U1453A keypad functions (continued)

Legend	Function when pressed for:	
	Less than 1 second	More than 1 second
	<p>Press  to switch or cycle between the default and <b>alternate</b> measurement function(s).</p> <hr/> <p><b>T:</b> Configures the tester for a timed test (when the rotary switch is in one of the  <b>Mega</b> positions or the  <b>EB</b> position). The test will start when you press .</p> <hr/> <p><b>DAR:</b> Configures the tester for a dielectric absorption ratio test (when the rotary switch is in one of the  <b>Mega</b> positions). The test will start when you press .</p> <hr/> <p><b>PI:</b> Configures the tester for a polarization index test (when the rotary switch is in one of the  <b>Mega</b> positions). The test will start when you press .</p>	<p><b>Log:</b> The recording option (HAND, AUTO, or TRIG) must first be selected in the Setup menu (see <a href="#">page 110</a>).</p> <ul style="list-style-type: none"> <li>HAND (manual data logging) — Press and hold  to log the present reading into the memory. The display will return to normal after a short while (<math>\approx 1</math> second). To manually log another reading, press and hold  again.</li> <li>AUTO (automatic data logging) — Press and hold  to enable the automatic data logging mode, where data is logged at the interval defined in the Setup menu (see <a href="#">page 110</a>). Press and hold  again to exit this mode.</li> <li>TRIG (event data logging) — Press and hold  to enable the event data logging mode, where data is logged each time a triggering condition is satisfied (see <a href="#">page 96</a>). Press and hold  again to exit this mode.</li> </ul>
	<p><b>Limit:</b> Press  to enable the comparison for limit mode.</p> <ul style="list-style-type: none"> <li>Press  again to set the comparison value. Use the arrow keys (<a href="#">page 100</a>) to change the value shown and press  to save your changes.</li> <li>Press and hold  to exit this mode.</li> </ul>	<p><b>Max Min:</b> Press and hold  to start the Max Min recording.</p> <ul style="list-style-type: none"> <li>Press  again to cycle through maximum (<b>REC MAX</b>), minimum (<b>REC MIN</b>), average (<b>REC AVG</b>), and present (<b>REC NOW</b>) readings.</li> <li>Press and hold  again to exit this mode.</li> <li>Max Min is disabled when Trip tests are enabled.</li> </ul>
	<p></p> <p><b>Trip:</b> When the rotary switch is in one of the  <b>Mega</b> positions, first press  to display the leakage current. Then, press  to cycle through the various Trip tests for insulation resistance measurement. The test will start when you press .</p> <ul style="list-style-type: none"> <li>Trip by leakage current</li> <li>Trip by stepped voltage (Scan)</li> <li>Trip by stepped voltage (Ramp)</li> </ul>	

**Table 1-4** U1461A/U1453A keypad functions (continued)

Legend	Function when pressed for:	
	Less than 1 second	More than 1 second
<p><b>Auto Leak</b></p> 	<p><b>Range:</b> Press  to set a manual range and disable auto-ranging.</p> <ul style="list-style-type: none"> <li>Press  again to cycle through each available measurement range.</li> <li>Press  during temperature measurements to change the temperature measurement unit between Celsius (°C) and Fahrenheit (°F). This option must first be enabled in the Setup menu (see <a href="#">page 139</a>).</li> </ul> <p><b>Leak:</b> Press  to display the leakage current.</p>	<p><b>Auto:</b> Press and hold  to enable auto-ranging.</p> <hr/> <p><b>Auto:</b> Press and hold  during diode tests to enable the Auto-diode feature. Press and hold  again to exit this mode.</p>
<p><b>Vsense</b></p> 	<p><b>Null:</b> Press  to enable the relative function.</p> <ul style="list-style-type: none"> <li>The displayed value is saved as a reference to be subtracted from subsequent measurements.</li> <li>Press  again to view the stored reference value that has been saved. The display will return to normal after a brief period of time (approx. 3 seconds).</li> <li>Pressing  while the stored reference value is being displayed will cancel the relative function.</li> </ul>	<p><b>Vsense (model U1461A only):</b> Press and hold  to enable the non-contact voltage presence indicator.</p> <ul style="list-style-type: none"> <li>Press  to change the Vsense detector's sensitivity from <b>HIGH SENSE</b> to <b>LOW SENSE</b>.</li> <li>Press and hold  again to exit this mode.</li> </ul>
<p><b>Setup</b></p> 	<p><b>☼:</b> Press  to increase or decrease the OLED brightness. This option must first be enabled in the Setup menu (see <a href="#">page 116</a>).</p>	<p><b>Setup:</b> Press and hold  to enter the Setup menu.</p> <ul style="list-style-type: none"> <li>In the Setup menu, press  or  to navigate through the menu pages. Press  or  at each menu page to move the cursor to a specific menu item.</li> <li>Press  to change the value of the selected menu item. Use the arrow keys (<a href="#">page 100</a>) to change the value shown.</li> <li>Press  again to save your changes, or press  to discard your changes.</li> <li>Press and hold  again to exit the Setup menu.</li> </ul>

## Display screen

The display annunciators of your tester are described in this section. See also “Measurement units” on page 26 for a list of available measurement signs and notations and “Analog bar graph” on page 27 for a tutorial on the analog bar graph located at the bottom of your display screen.





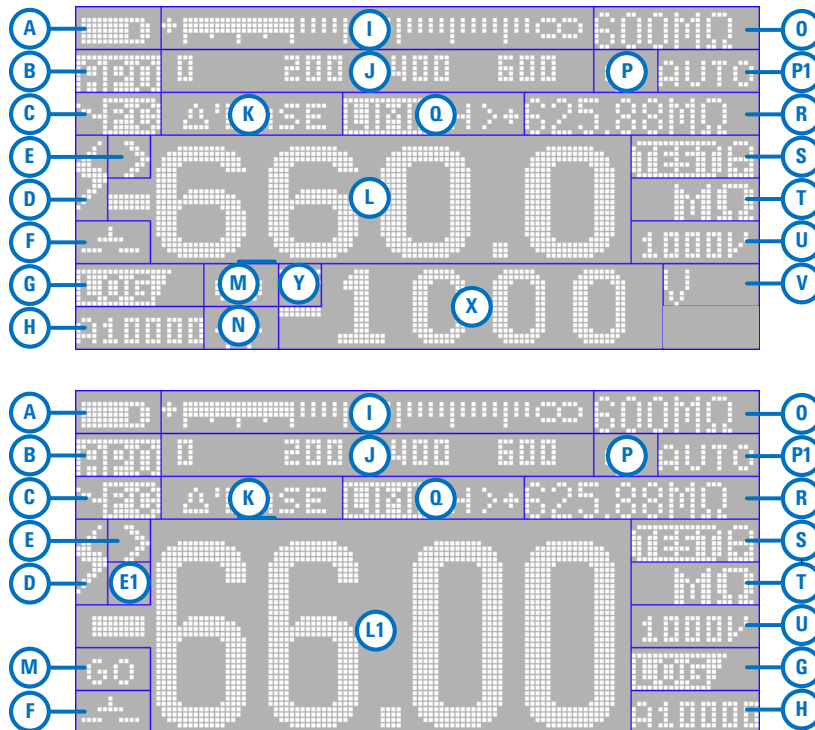







### General display annunciators

The general display annunciators of your tester are described in the Table 1-5.



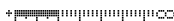

**Figure 1-5** Display screen allocation example

**Table 1-5** General annunciators

Area	Legend	Description
A		Battery capacity indication
B		APO (Auto Power-Off) enabled
C		Remote control enabled
D		Hazardous voltage sign for measuring voltage $\geq 30$ V or OL (overload)
E		Greater than range (for insulation resistance and earth-bond resistance tests)
		Type-J/Type-K thermocouple selected
E1		Polarity (for dual displays)
		<ul style="list-style-type: none"> <li>Capacitor is charging (during capacitance measurement)</li> <li>Positive slope for pulse width (<b>ms</b>) and duty cycle (%) measurements</li> </ul>
		<ul style="list-style-type: none"> <li>Capacitor is discharging (during capacitance measurement)</li> <li>Negative slope for pulse width (<b>ms</b>) and duty cycle (%) measurements</li> </ul>
F		Short continuity indication
		Open continuity indication
		Data logging in progress
		View mode for reviewing previously logged data















**Table 1-5** General annunciators (continued)

Area	Legend	Description
<b>H</b>	A:Full	Index for AUTO (automatic), HAND (manual), and TRIG (event) data logging
	A:Void	
	H001	
	H100	
	A1000 E1000	
<b>I</b>		Analog bar graph
<b>J</b>	0 200 400 600	Scale of analog bar graph
<b>K</b>	ΔNULL	Relative (Null) enabled
	Δ'BASE	Relative value when Null is enabled
<b>L</b>	-660.0	Primary measurement display (medium)
<b>L1</b>	-66.00	Primary measurement display (large)
<b>M</b>	GO	Comparison result for Limit mode
	NG	
	HI	
	LO	
<b>N</b>		Reverse diode indication for Auto-diode test
<b>O</b>	1000mV	Range indication
	600MΩ	
<b>P</b>		Smooth mode enabled
<b>P1</b>	AUTO	Auto-ranging enabled, Auto-diode enabled, or Auto signal indicator enabled

**Table 1-5** General annunciators (continued)

Area	Legend	Description
		Maximum reading shown on primary display
		Minimum reading shown on primary display
		Averaged reading shown on primary display
		Present reading shown on primary display
		Auto hold enabled
		Trigger hold enabled
Q		Timed test enabled
		Dielectric Absorption Ratio test enabled
		Polarization Index test enabled
		Limit comparison enabled
		Overcurrent indication
		Trip enabled
	-40.0°C	Ambient temperature indication
R	99999s	Elapsed time for Recording mode
	00:59	Timer display for T, DAR, and PI tests
R+S		Limit value indication for comparison

**Table 1-5** General annunciators (continued)

Area	Legend	Description
S		AC, DC, and AC+DC indication for primary display
		Low-pass filter enabled for AC measurement
		Diode test enabled
		Temperature measurement without ambient compensation selected
		Test and Test Lock indication for insulation resistance and earth-bond resistance tests
T		Measuring units for primary display
		Test voltage for insulation resistance
U		% Scale of 4-20 mA or 0-20 mA
		Audible continuity test selected
		Audible disabled
V		Tone enabled
		Measuring units for secondary display

**Table 1-5** General annunciators (continued)

Area	Legend	Description
X		Secondary measurement display
Y		AC, DC, and AC+DC indication for secondary display

### Measurement units

The available signs and notations for each measurement function in your tester are described in [Table 1-6](#). The units listed below are applicable to the primary display and secondary display measurements of your tester.

**Table 1-6** Measurement units display

Sign/Notation	Description
T	Tera 1E+12 (1000000000000)
G	Giga 1E+09 (1000000000)
M	Mega 1E+06 (1000000)
k	kilo 1E+03 (1000)
n	nano 1E-09 (0.000000001)
μ	micro 1E-06 (0.000001)
m	milli 1E-03 (0.001)
mV, V	Voltage, units for voltage measurement
A, mA, μA, nA	Ampere, units for current measurement
nF, μF, mF	Farad, units for capacitance measurement
Ω, kΩ, MΩ, GΩ	Ohm, units for resistance measurement
kHz, Hz	Hertz, units for frequency measurement
ms	Millisecond, unit for pulse width measurement

**Table 1-6** Measurement units display (continued)

Sign/Notation	Description
%	Percent, unit for duty cycle measurement
°C	Degree Celsius, unit for temperature measurement
°F	Degree Fahrenheit, unit for temperature measurement
m, km	Meter, units for length
ft	Feet, unit for length
s	Seconds, unit for Recording mode elapsed time

### Analog bar graph

The analog bar emulates the needle on an analog tester, without displaying the overshoot.

**NOTE**

For frequency, duty cycle, pulse width, 4-20 mA % scale, 0-20 mA % scale, and temperature measurements, the bar graph does not represent the primary display value.

For example, when frequency, duty cycle, or pulse width is displayed on the primary display during voltage or current measurement, the bar graph represents the voltage or current value (not the frequency, duty cycle, or pulse width value). Another example is when 4-20 mA % scale or 0-20 mA % scale is displayed on the primary display, the bar graph represents the current value and not the percentage value.

The “+” or “-” sign indicates whether the measured or calculated value is positive or negative. Each bar represents 10 to 100 counts depending on the display count and range selected.



**Figure 1-6** Analog bar graph example

See [Table 1-7](#) for the relevant display counts, span, and counts per bar.

**Table 1-7** Analog bar graph display counts/bar

<b>Display counts</b>	<b>Span 1</b>	<b>Counts/bar</b>	<b>Span 2</b>	<b>Counts/bar</b>
6000	0 to 200	10	>200	20
1000	0 to 200	10	>200	40
2000	0 to 400	20	>400	80





## Input terminals

**WARNING**

To avoid damaging this device, do not exceed the input limit.

The terminal connections for the different measurement functions of your tester are described in the table below.

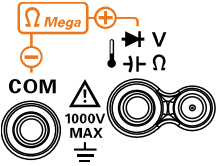
**Table 1-8** Terminal connections for different measuring functions

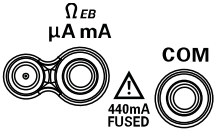
Rotary switch position	Input terminals	Overload protection
		1000 Vrms
 		1000 Vrms for short circuit <0.3 A
		440 mA/1000 V, 30 kA fast-acting fuse

Remote switch probe terminal for IR and EBR tests

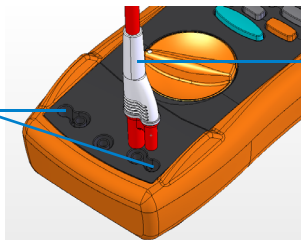

The remote switch probe is used for insulation resistance (IR) and earth-bond resistance (EBR) tests.

**Figure 1-7** Connecting the remote switch probe

## Cleaning Your Tester

**WARNING**

To avoid electrical shock or damage to the tester, ensure that the insides of the casing stay dry at all times.

---

Dirt or moisture in the terminals can distort readings. Follow the steps below to clean your tester.

- 1 Turn the tester off, and remove the test leads.
- 2 Turn the tester over, and shake out any dirt that may have accumulated in the terminals.

Wipe the case with a damp cloth and mild detergent – do not use abrasives or solvents. Wipe the contacts in each terminal with a clean swab dipped in alcohol.



## Additional Features

### Automatic power-off

Your tester automatically turns off if the rotary switch is not moved or a key is not pressed for 10 minutes (default). Pressing any key will turn the tester back on after it is powered off automatically.

To change the timer period or completely disable the automatic power-off, refer to [“Changing the auto power-off \(APO\) timer”](#) on page 116.

### OLED Auto Dim function

Your tester’s OLED automatically dims if the rotary switch is not moved or a key is not pressed for 90 seconds (default). This auto dim behavior is enabled by default. Pressing any key or changing the rotary switch position will cancel this effect and reset the auto dim timer.

To disable the auto dim, refer to [“Changing the OLED behavior”](#) on page 116.

### Change the OLED brightness

#### NOTE

The auto dim function is enabled by default. Refer to [“Changing the OLED behavior”](#) on page 116 to disable the auto dim function before you can manually change the OLED brightness.

If viewing the display becomes difficult in low-light conditions, press  to change the OLED brightness (this option must first be enabled in the Setup, see [“Changing the OLED behavior”](#) on page 116 for more information).

The **LOW**, **MEDIUM**, or **HIGH** setting must be selected in the tester's Setup (browse to **Menu 3 > BACKLIT**) prior to this action. Pressing  repeatedly will cycle the OLED brightness from low to medium to high (and back to low again).

You are advised to select an suitable brightness level based on your needs to conserve battery life if you wish to control the OLED brightness level manually.



## Hazardous voltage indication

The tester will display the hazardous voltage () symbol as an early precaution when the measured voltage is equal to or greater than  $\pm$ DC 30 V or AC 30 V, or when the measured voltage is over the measurement range, **OL** (overload).



## Power-on options

Some options can be selected only while you turn the tester on. These power-on options are listed in the table below. To select a power-on option, press and hold the specified key while turning the rotary switch from the **OFF** position to any other position. Power-on options remain selected until the tester is turned off.

**Table 1-9** Power-on options

Key	Description
	Displays the power-on greeting. Press any key to exit this mode.
	Simulates the Auto Power-Off (APO) mode. Press any key to turn the tester back on and resume normal operation.
	Checks firmware version and serial number. The tester's firmware version and serial number will be shown on the primary display. Press any key to exit this mode.

**Table 1-9** Power-on options (continued)

Key	Description
	<p>Toggles the red LED indicator alert for insulation resistance tests. If enabled, the red LED indicator will blink every two seconds during an insulation resistance test.</p> <p>The red LED indicator alert is disabled when the Limit feature (see <a href="#">page 90</a>) is enabled.</p>
	<p>Smooth is enabled until the tester is turned off. To permanently enable Smooth, see “<a href="#">Enabling smooth mode</a>” on page 112.</p>
	<p>Tests the OLED. All OLED pixels are lighted. Use this mode to verify that there are no dead OLED pixels. Press any key to exit this mode.</p>

**THIS PAGE HAS BEEN INTENTIONALLY LEFT BLANK.**



## 2 Making Measurements

Insulation Resistance Test	36
Using the Remote Switch Probe	38
Locking the test	39
Timed (T) insulation resistance/earth-bond resistance test	40
Measuring the Dielectric Absorption Ratio (DAR)	41
Measuring the Polarization Index (PI)	42
Viewing the leakage current	43
Performing leakage current trip tests	43
Performing stepped voltage trip tests	45
Earth-Bond Resistance Test	51
Measuring AC or DC Voltage	54
Auto AC or DC signal identification	56
Using the LPF (Low Pass Filter) feature for AC signals	57
Enabling the LPF in the Setup	59
Measuring AC or DC Current	60
% Scale of 4-20 mA or 0-20 mA	62
Measuring Frequency	63
Measuring duty cycle and pulse width	65
Measuring Resistance	66
Continuity Test	68
Diode Test	70
Using the Auto-diode feature	73
Measuring Capacitance	75
Viewing the cable length value	77
Measuring Temperature	78







The following sections describe how to take measurements with your tester.



## Insulation Resistance Test

Set up your tester as shown in [Figure 2-1](#). Set the rotary switch to a test voltage value that does not exceed the maximum voltage limitation of the circuit under test. Ensure that the device-under-test (DUT) is de-energized before performing any resistance measurement.

**Table 2-1** Rotary switch position for insulation resistance tests

Legend	Default function		Function when  is pressed	
	Primary display	Secondary display	Primary display	Secondary display
	50 V insulation resistance test			
	100 V insulation resistance test		1 Timed (T) test	
	250 V insulation resistance test	AC+DC V or DC V (during test)	2 Dielectric Absorption Ratio (DAR) test	AC+DC V or DC V (during test)
	500 V insulation resistance test		3 Polarization Index (PI) test	
	1000 V insulation resistance test			

### CAUTION

- **DO NOT** perform insulation resistance test in distribution systems with voltages higher than 600 V.
- The tester automatically detects if the circuit is energized. If the external voltage is detected to be greater than 30 V (or 50 V or 75 V; depending on selected option in Setup), the test is inhibited. The symbol  is shown on the display when either the external voltage or the test voltage is greater than 30 V. Disconnect the tester and remove the power of the circuit before proceeding.

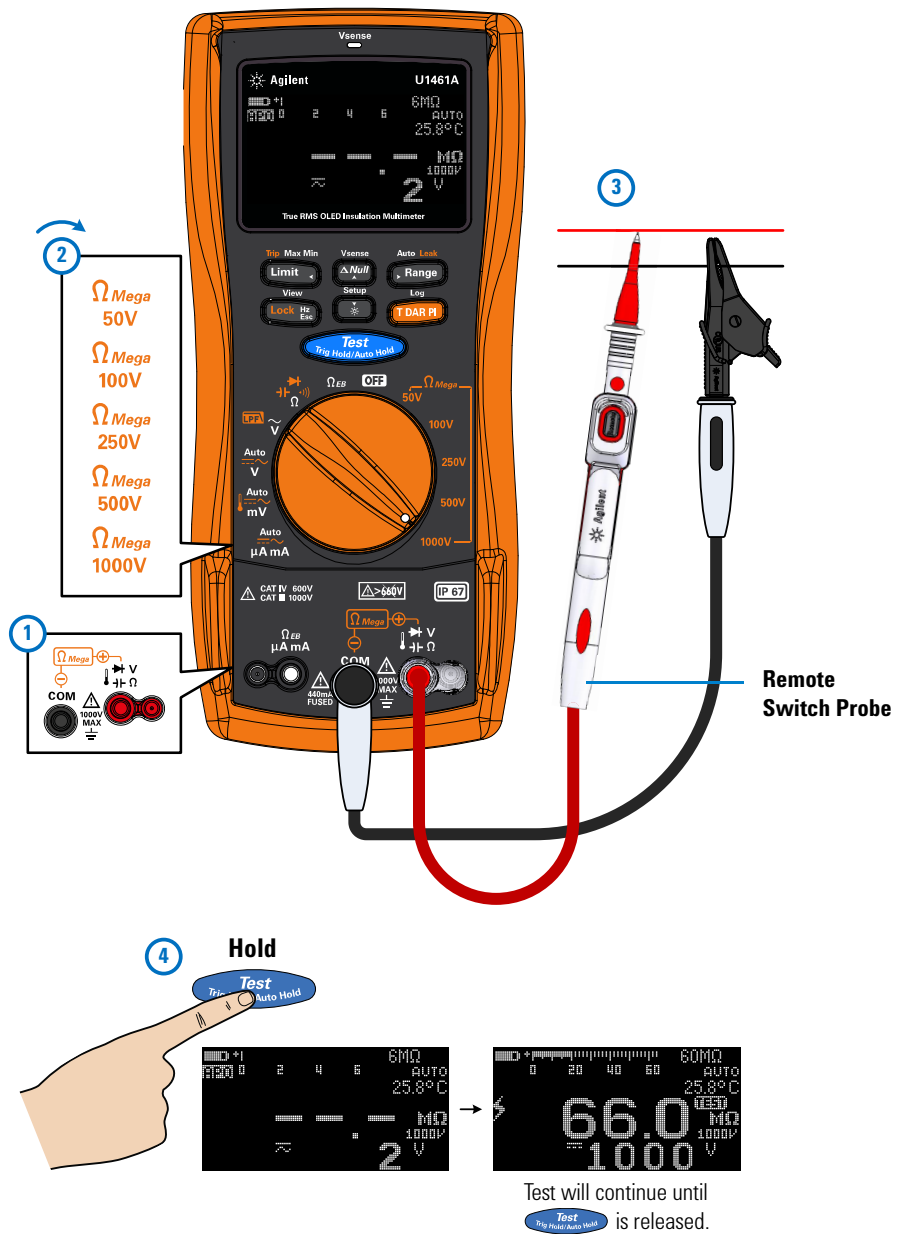

Figure 2-1 Insulation resistance test example

## 2 Making Measurements

### Insulation Resistance Test

#### CAUTION

The insulation meter will auto-discharge the DUT when the test is complete. However, the DUT will not be auto-discharged when you disconnect the probe before the test is complete. Avoid touching the DUT when the DUT is not fully discharged as it may lead to possible electric shock.

#### NOTE

When an insulation test is in progress, the red LED indicator at the top of the tester will blink every 2 seconds (if the Limit function is not enabled). To disable this feature see [“Power-on options”](#) on page 32.

## Using the Remote Switch Probe

The Remote Switch Probe (included in shipment) is used with insulation resistance tests and earth-bond resistance tests, enabling the tester to be controlled remotely from the button on the Remote Switch Probe.

By default the button on the Remote Switch Probe emulates the

Test  
Trig Hold/Auto Hold

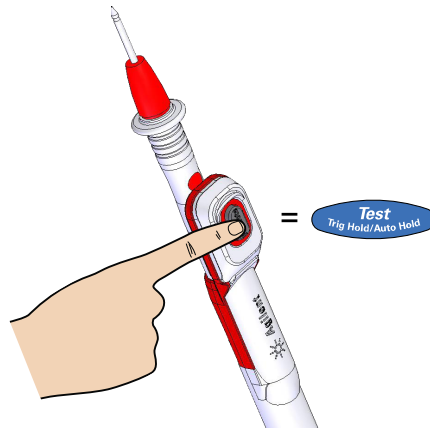

To change the default button operation, see [“Changing the button operation on the remote switch probe”](#) on page 130



## Locking the test

You can lock the insulation resistance tests or earth-bond resistance tests temporarily.

Press **Lock Hz Esc** to enable the lock once feature. The  symbol will be shown on the display. The test will start when you press **Test Trip Hold/Auto Hold** and it remains active until **Test Trip Hold/Auto Hold** or **Lock Hz Esc** is pressed again.

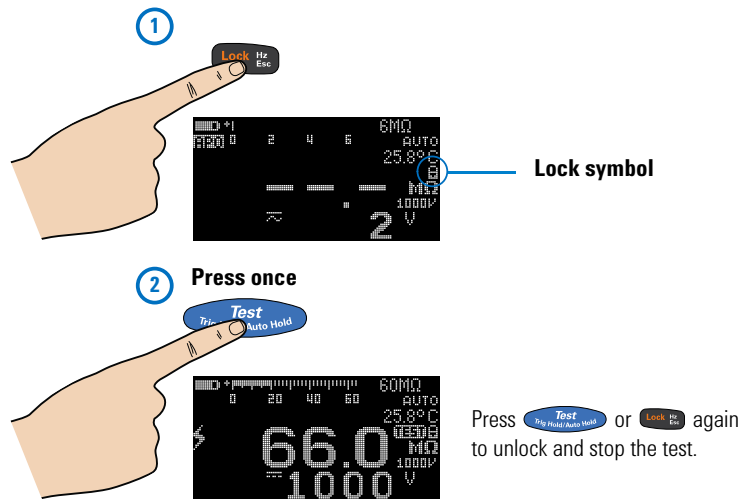

By default, the tester will reset the locked status when the test is stopped by pressing **Test Trip Hold/Auto Hold** or **Lock Hz Esc**. See “Disabling the lock once feature” on page 131 to disable this feature.

If you disable this feature, you will need to press **Lock Hz Esc** to unlock the tester, even if the test has already stopped.

## Timed (T) insulation resistance/earth-bond resistance test

Use the timed test to obtain measurement results with consistent test times – for later comparisons. Set up your tester as shown in [Figure 2-1](#), and follow the steps shown below.

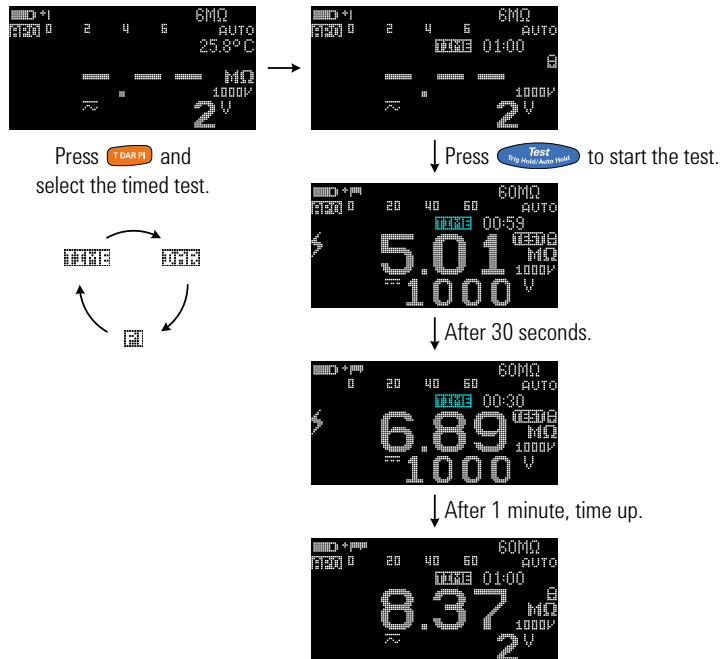

**Figure 2-2** T operation

**NOTE**

- Because of the time required to perform the T, PI, and DAR tests, the use of alligator test clips is recommended.
- The length of the timer is 1 minute by default. To change this value, see [“Changing the insulation resistance and earth-bond resistance test period”](#) on page 135 for more information.

## Measuring the Dielectric Absorption Ratio (DAR)

Dielectric Absorption Ratio (DAR) is the ratio of the insulation resistance tested at 60 seconds to the insulation resistance tested at 30 seconds. Set up your tester as shown in [Figure 2-1](#), and follow the steps shown below.

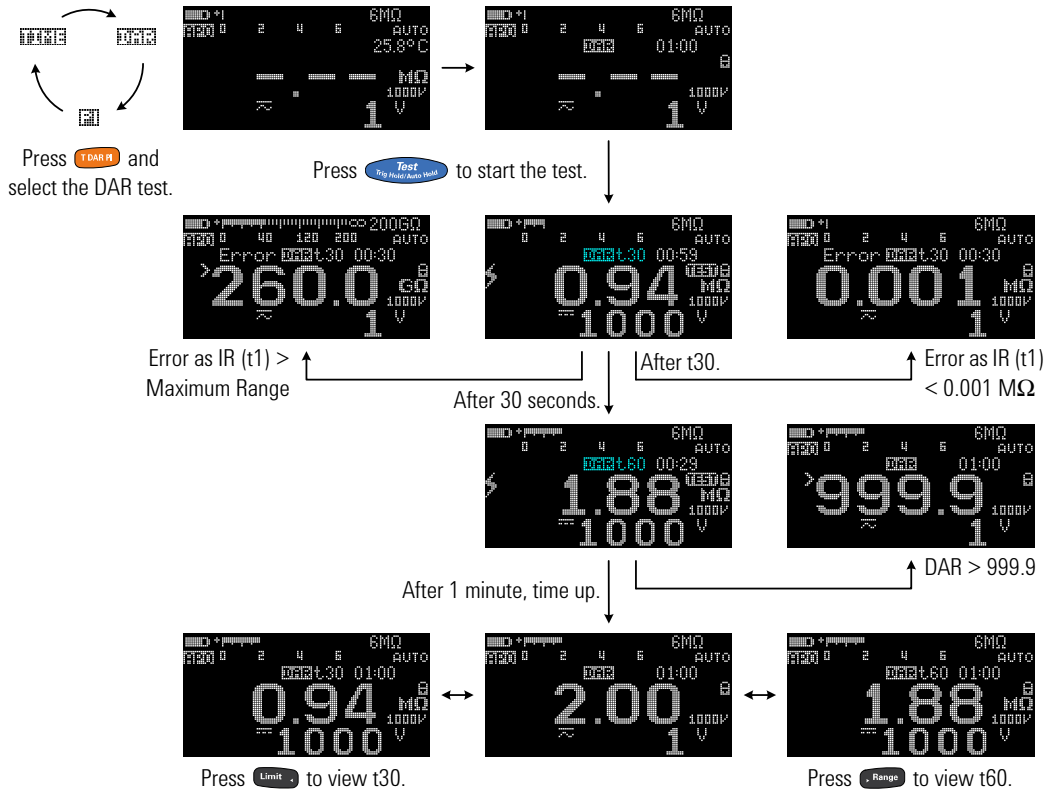

**Figure 2-3** DAR operation

### NOTE

You can change the DAR from 60:30 to 60:15 in the Setup. See [“Changing the Dielectric Absorption Ratio \(DAR\) for insulation resistance tests”](#) on page 132 for more information. **Error** is shown on the display if the IR is greater than the maximum range or less than 0.001 MΩ after t1/t15/t30; if the test is interrupted by the user; or if the tester’s battery is low.

## Measuring the Polarization Index (PI)

Polarization Index (PI) is the ratio of the insulation resistance tested at 10 minutes to the insulation resistance tested at 1 minute. Set up your tester as shown in [Figure 2-1](#), and follow the steps shown below.

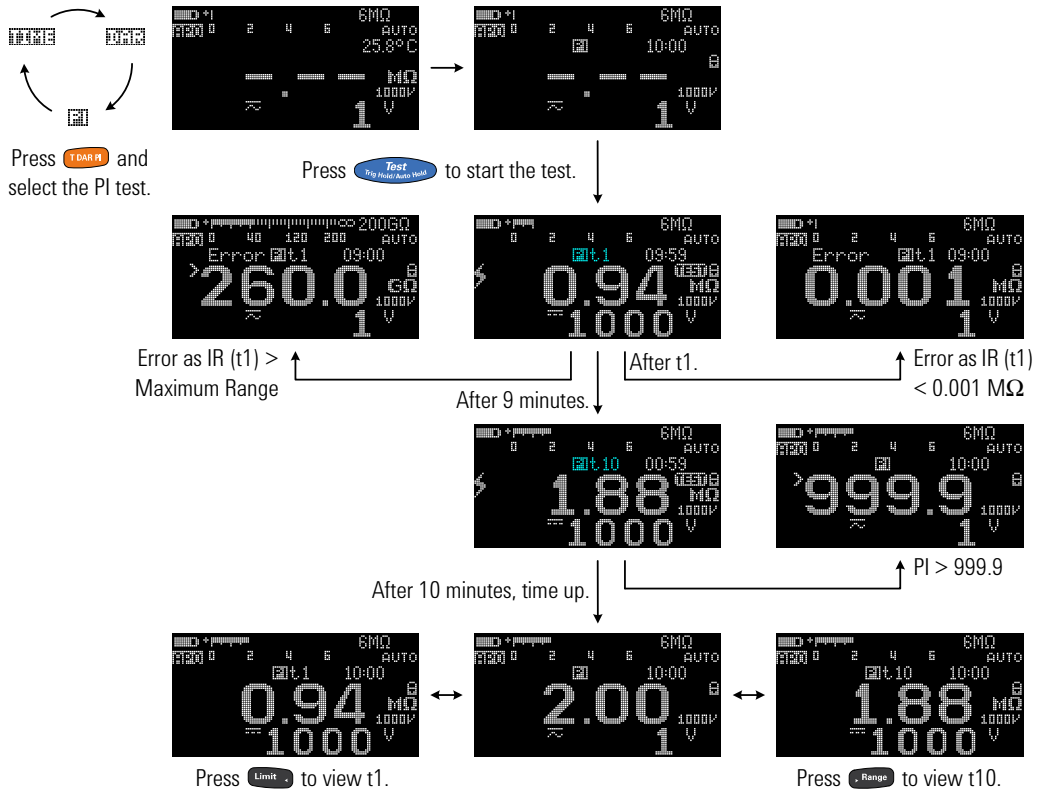

**Figure 2-4** PI operation

### NOTE

**Error** is shown on the display if the IR is greater than the maximum range or less than 0.001 MΩ after t1/t15/t30; if the test is interrupted by the user; or if the tester's battery is low.

## Viewing the leakage current

Press **Range** to view the leakage current display. The leakage current display is related to the insulation resistance. The higher the resistance tested, the lower the current is to be measured.

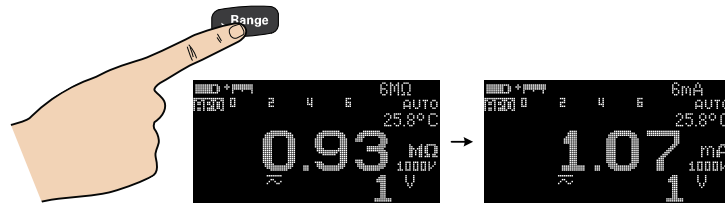

## Performing leakage current trip tests

This function may be used to test MOVs (Metal Oxide Varistors), gas discharge tubes, voltage arresters, or sparking gaps. The voltage source will be stopped when the current is greater than the trip current set.

You can select the test voltage and set the current for tripping the test. The trip or breakdown current can be adjusted from 0.001 mA to 1.500 mA from the Setup (see [page 137](#)) or by pressing **ΔNull** before starting the test.

### NOTE

T/DAR/PI tests, Null, Limit, and test lock is disabled when leakage current trip tests or stepped voltage trip tests are enabled.

Set up your tester as shown in [Figure 2-1](#), and follow the steps shown in [Figure 2-5](#).

## 2 Making Measurements

### Insulation Resistance Test

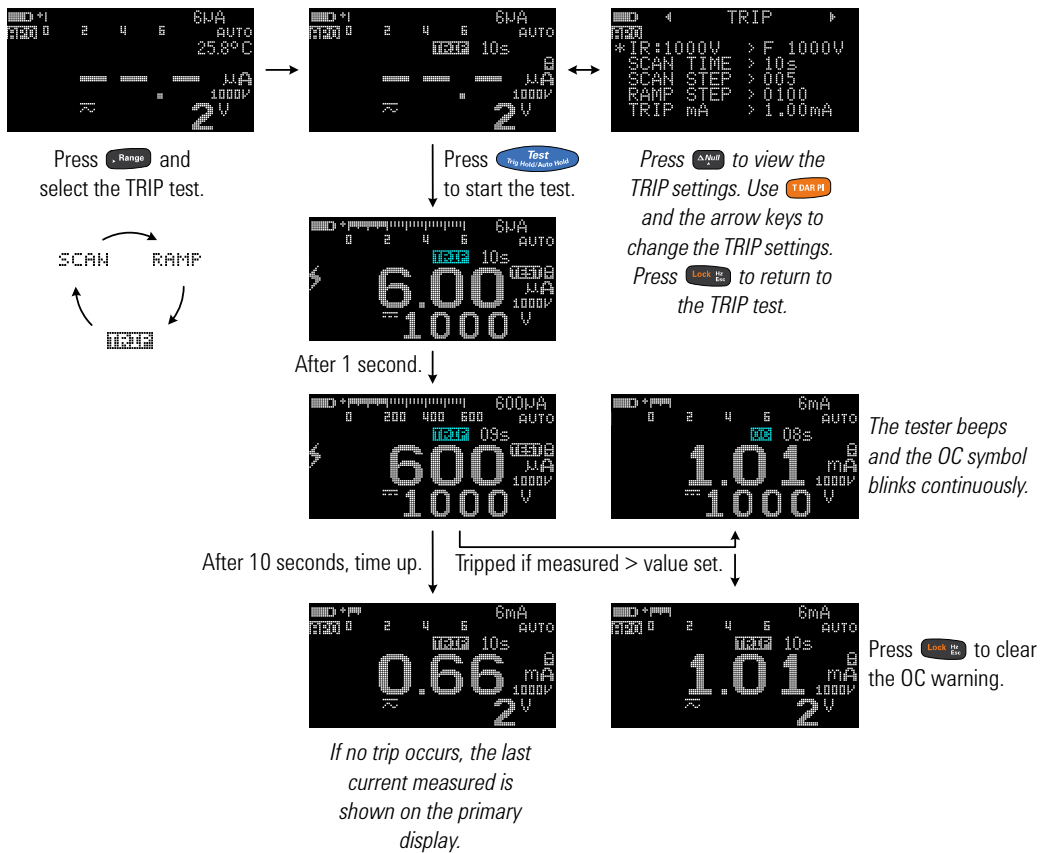

**Figure 2-5** TRIP operation

## Performing stepped voltage trip tests

### Scan

A typical scan signal length is based on the following parameters:

- **IR TEST VOLTAGE** - the amplitude end position
- **SCAN STEP** - the number of steps required to reach the amplitude end position
- **SCAN TIME** - the dwelling time length for each step

### NOTE

- The TRIP test method involves the application of high direct voltage in a series of uniform voltage steps at regular time intervals. The minimum voltage step is 10 V. Each step should be set to greater than 10 V and the last step is equal to or less than the test voltage setting.
- As an example, if the SCAN STEP is set to 5; for the 1000 V test voltage setting, the test voltage is sent out at the following intervals: 200 V, 400 V, 600 V, 800 V, and 1000 V.

---

You can configure the scan signal amplitude end position, number of steps (1 to 100 steps), and dwelling time length (1 to 99 seconds) in the Setup (see [page 135](#) and [page 136](#)) or by pressing  before starting the test.

## 2 Making Measurements

### Insulation Resistance Test

The total dwell time will increase with respect to the number of steps and the scan dwell time per step selected. The scan dwell time is defined as the length of time the scan signal will “dwell” in the present step before incrementing to the next step.

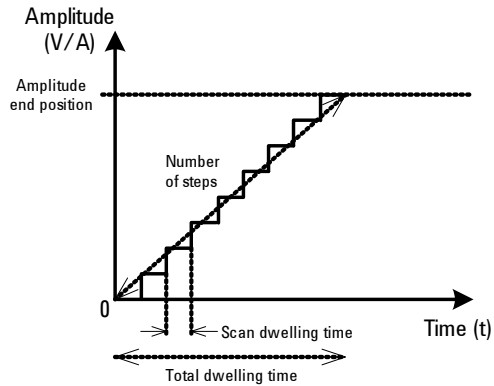

**Figure 2-6** Scan signal



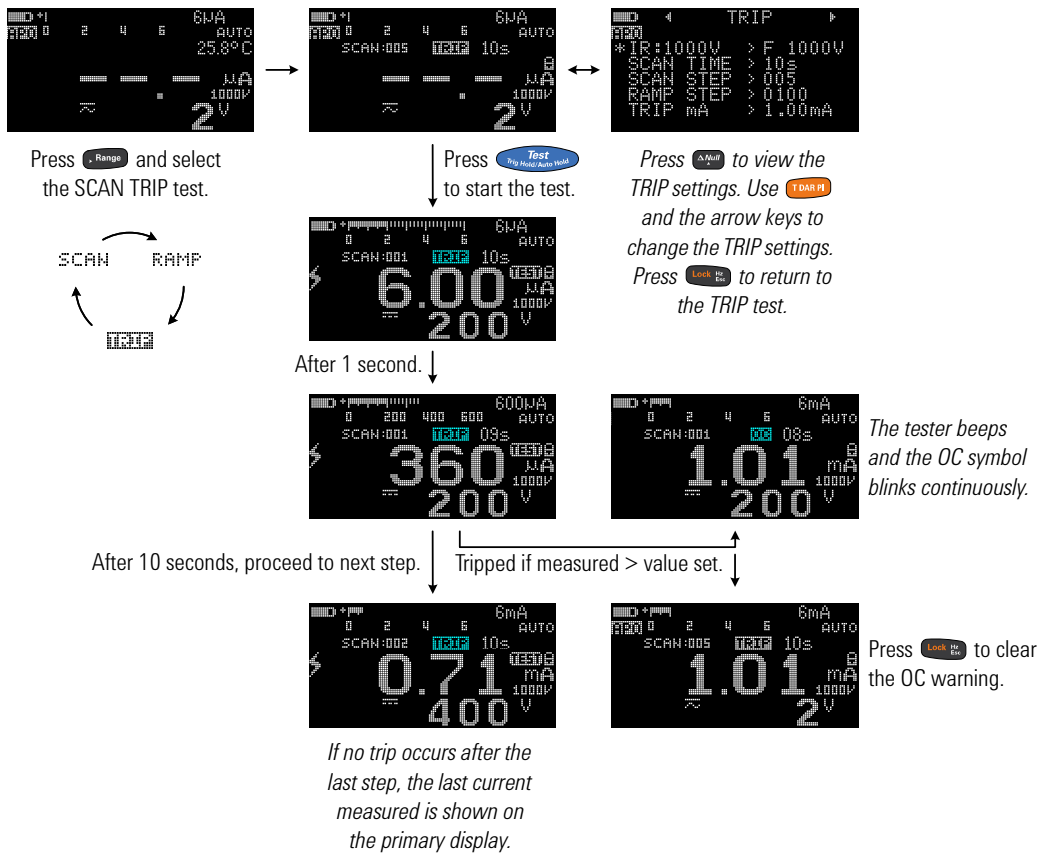

Figure 2-7 SCAN TRIP operation

### Ramp

A typical ramp signal length is based on the following parameters:

- **IR TEST VOLTAGE** - the amplitude end position, and
- **RAMP STEP** - the number of steps required to reach the amplitude end position.

#### NOTE

The principal advantages of the ramped voltage test over the conventional stepped voltage methods are that it gives better control and improved warning of impending failure to avoid damage to the insulation. Elimination of the human variable from the time, voltage, and current parameters yields overall test results which are much more accurate and repeatable.

You can configure the ramp signal amplitude end position and number of steps in the Setup (see [page 137](#)) or by pressing  before starting the test.

The ramp dwelling time will be set to the fastest of the instrument capability. A higher number of steps provides a more linear ramp signal. This however will result in an increase in the total dwelling time.

A lower number of steps will result in a shorter total dwelling time and a more stepped ramp signal.

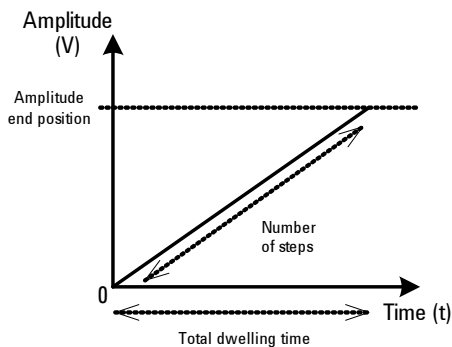

**Figure 2-8** Ramp signal

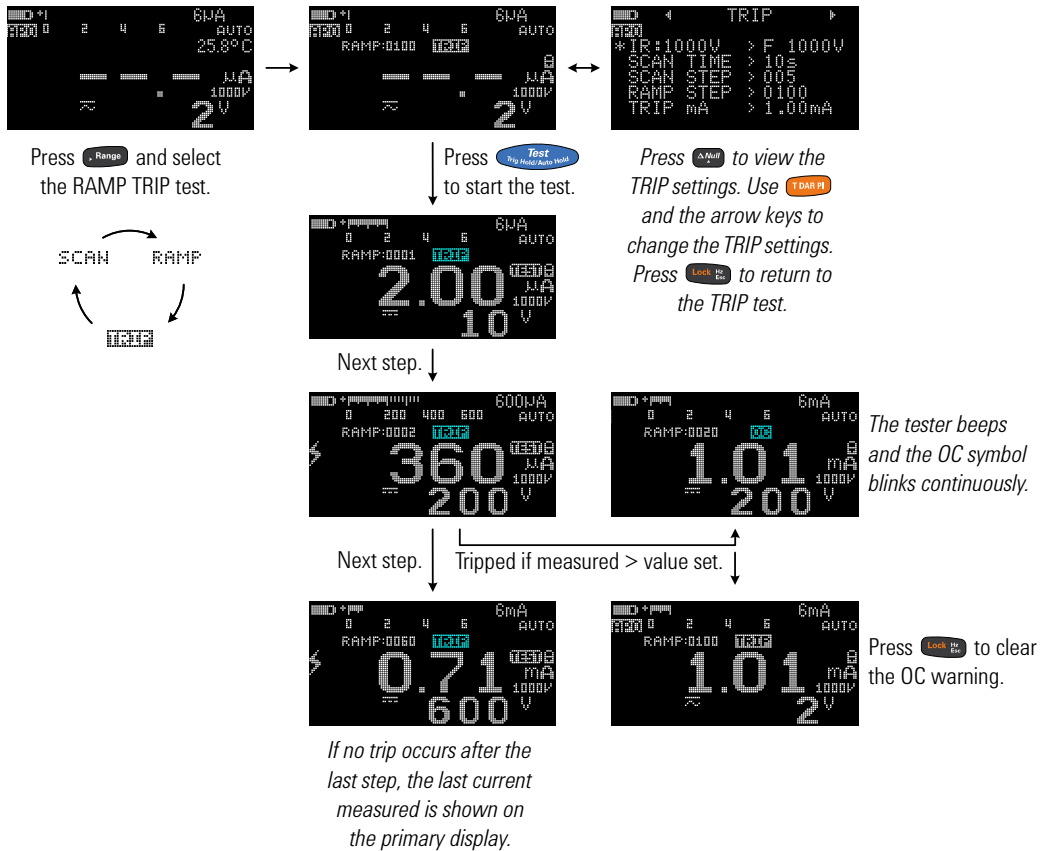

Figure 2-9 RAMP TRIP operation

## Changing the insulation resistance test voltage

You can adjust the test voltage value of each test voltage position (see Table 2-1) from the Setup menu (“Menu 8”).

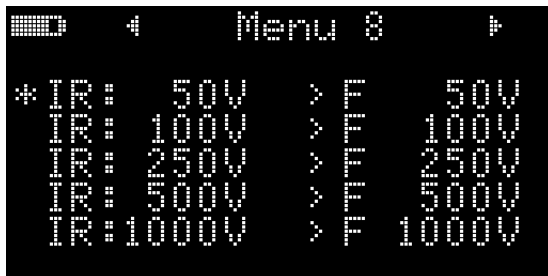

Table 2-2 lists the available range for each test voltage position. See “Changing the insulation resistance test voltage” on page 133 for more information.

**Table 2-2** User test voltage range for insulation resistance

Rotary switch position	Parameter	Range	
		F(actory) default	Available U(ser) range <sup>[1]</sup>
$\Omega$ Mega 50V	IR: 50 V	50 V	10 V to 60 V
$\Omega$ Mega 100V	IR: 100 V	100 V	10 V to 120 V
$\Omega$ Mega 250V	IR: 250 V	250 V	10 V to 300 V
$\Omega$ Mega 500V	IR: 500 V	500 V	10 V to 600 V
$\Omega$ Mega 1000V	IR: 1000 V	1000 V	10 V to 1100 V

[1] Minimum increment of 1 V between each subsequent value.

## Earth-Bond Resistance Test

Set up your tester to perform earth-bond resistance tests as shown in Figure 2-10.

**Table 2-3** Earth-bond resistance test position

Legend	Default function		Function when  is pressed	
Rotary switch position	Primary display	Secondary display	Primary display	Secondary display
$\Omega_{EB}$	Earth-bond resistance test	AC+DC V or DC V (during test)	Timed (T) test	AC+DC V or DC V (during test)

### CAUTION

- To avoid possible damage to your tester or to the equipment under test, disconnect the circuit power and discharge all high-voltage capacitors before measuring resistance.
- The tester automatically detects if the circuit is energized. If the external voltage is detected to be greater than 2 V, the test is inhibited and  is shown on the display. Disconnect the tester and remove power before proceeding.

### NOTE

- The earth-bond resistance function is used to measure the resistance between earth conductors, protective earth conductors, and conductors for equipotential bonding, including their connections and terminals. The function includes an indication of the measured value or indication of limits.
- The voltage source is <6.8 V, and the current is >200 mA when the resistance of  $\leq 2 \Omega$  is to be measured. When the source voltage is <4.7 V, the tester will inhibit the test automatically. The secondary display indicates the voltage (with auto-ranging enabled).
- The APO (auto power-off) function is disabled during the test.
- See also “Timed (T) insulation resistance/earth-bond resistance test” on page 40.

## 2 Making Measurements

### Earth-Bond Resistance Test

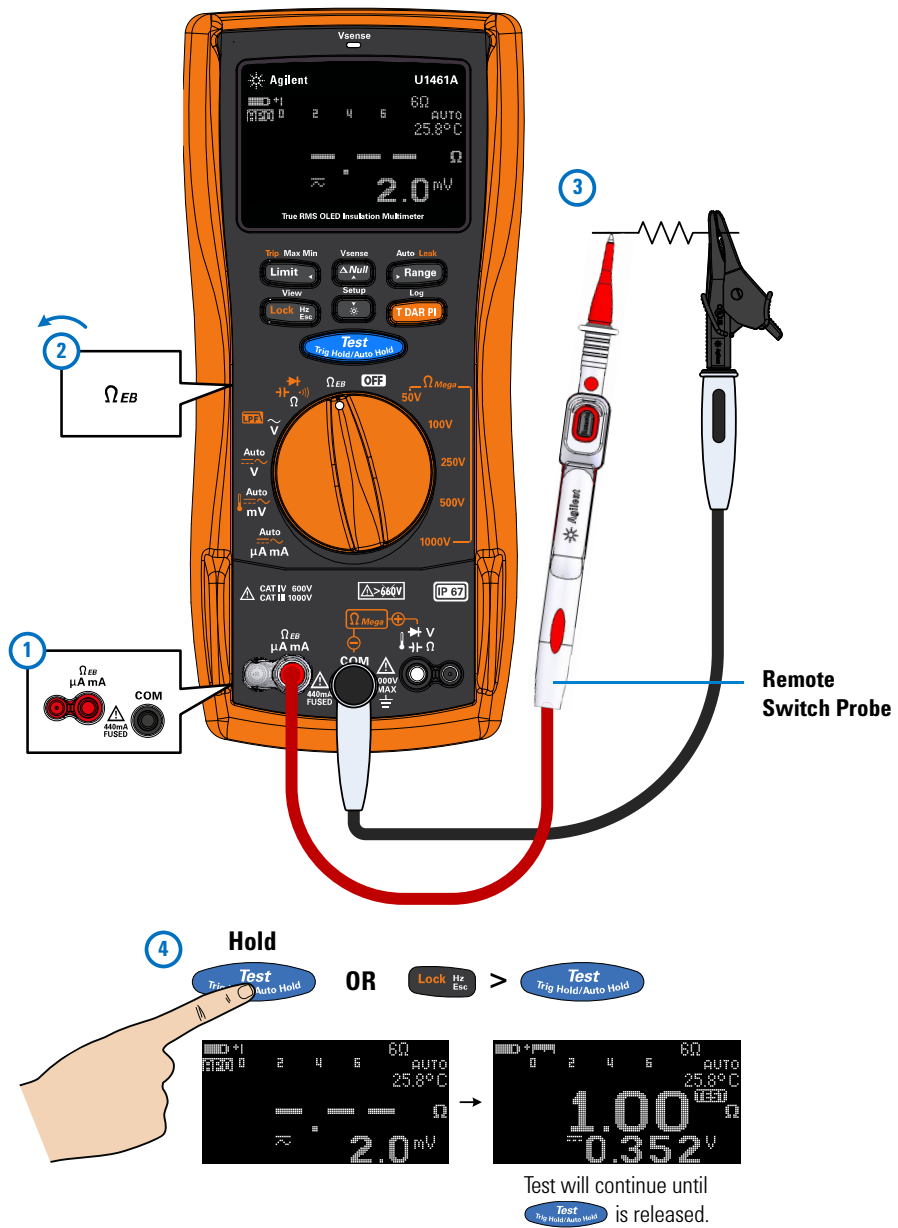



Figure 2-10 Earth-bond resistance test example

### Using the earth-bond resistance test to verify the fuse condition

- 1 Keep the test leads open, and ensure that no voltage is applied to the terminals.
- 2 Press and hold  to verify the fuse condition.
- 3 If the fuse has been blown, **FUSE OPEN** will be shown on the display. Follow the instructions in the *U1461A/U1453A Service Guide* to replace the fuse.







Fuse blown;  
replace fuse.



## Measuring AC or DC Voltage

Set up your tester to measure AC or DC voltage as shown in [Figure 2-11](#).

**Table 2-4** AC and DC voltage measurement positions

Legend	Default function		Function when  is pressed	
Rotary switch position	Primary display	Secondary display	Primary display	Secondary display
 	AC V	-	AC V with LPF	-
	AC V	-	-	-
			<i>Cycles between</i>	
	Auto (V)	AC+DC V	<ol style="list-style-type: none"> <li>1 DC V</li> <li>2 AC V</li> <li>3 Auto (V)</li> </ol>	<ol style="list-style-type: none"> <li>1 AC+DC V</li> <li>2 AC+DC V</li> <li>3 AC+DC V</li> </ol>
			<i>Cycles between</i>	
	Auto (mV)	AC+DC mV	<ol style="list-style-type: none"> <li>1 DC mV</li> <li>2 AC mV</li> <li>3 Temperature</li> <li>4 Auto (mV)</li> </ol>	<ol style="list-style-type: none"> <li>1 AC+DC mV</li> <li>2 AC+DC mV</li> <li>3 -, °C, or °F</li> <li>4 AC+DC mV</li> </ol>

### NOTE

- AC voltage measurements measured with this tester are returned as true RMS (root mean square) readings. These readings are accurate for sinusoidal waves and other waveforms with no DC offset, such as square waves, triangle waves, and staircase waves.
- This tester displays DC voltage values as well as their polarity. Negative DC voltages will return a negative sign on the left of the display.
- Press  to measure the frequency of the voltage source. See [“Measuring Frequency”](#) on page 63 to learn more.



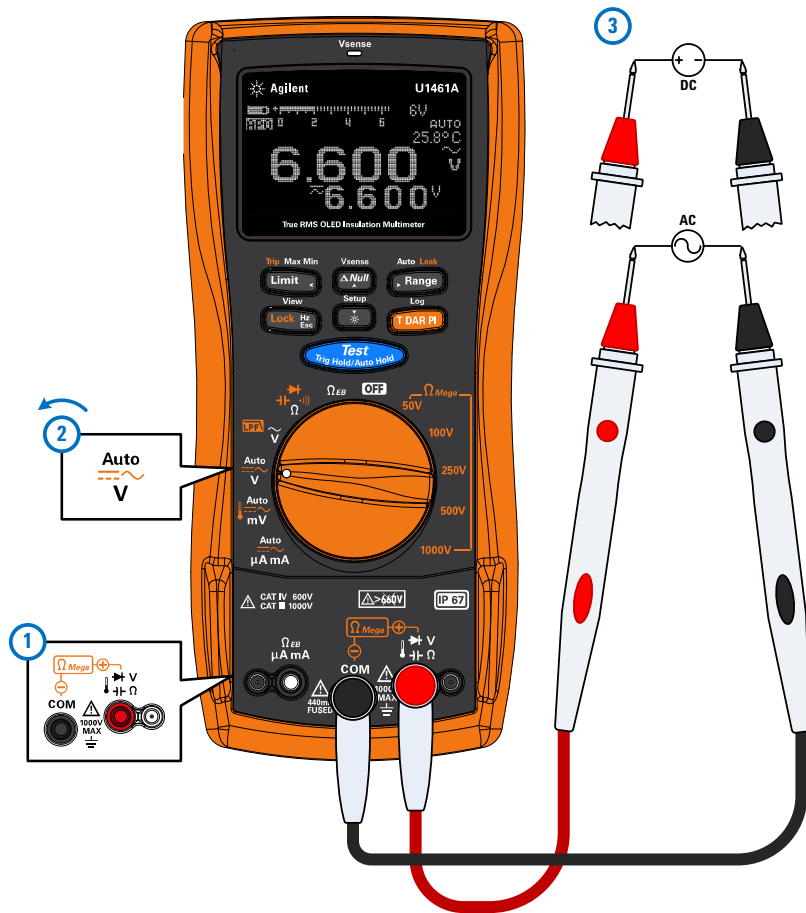
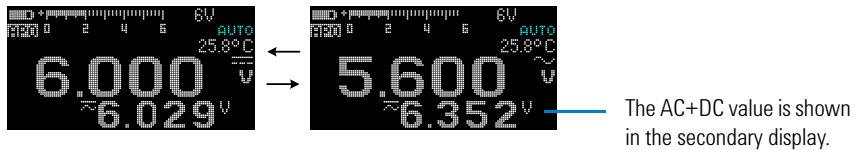

Figure 2-11 AC or DC voltage measurement example

## Auto AC or DC signal identification

The **Auto** function is able to automatically identify the signal component (AC or DC) of an electrical source and select a suitable measurement range according to the AC+DC reading.

The symbol **AUTO** blinks during the identification.



The **Auto** function identifies the signal component using the following rules:

- It will consider which component value is greater between the AC or DC.
- The AC value should be greater than a minimum value of 50 counts (based on 6000 counts) of range to prevent residual value due to range changing.
- The frequency measured is greater than 10 Hz for the AC mode.

While the signal is being identified, you can press **T/DAR/PI** to lock the (AC or DC) signal on the primary display.

At any time, you can press **Range** to stop the **Auto** function and lock the identified signal component (AC or DC).

## Using the LPF (Low Pass Filter) feature for AC signals

For model U1461A only: Your tester is equipped with an AC low-pass filter to help reduce unwanted electronic noise when measuring AC voltage or AC frequency.

Set up your tester to measure AC voltage as shown in Figure 2-11. Turn the rotary knob to **LPF**  $\tilde{\sim}$  and press **T DAB PI** to activate the LPF option. Your tester continues measuring in the chosen AC mode, but now the signal diverts through a filter that blocks unwanted voltages above 1 kHz. Probe the test points, and read the display.

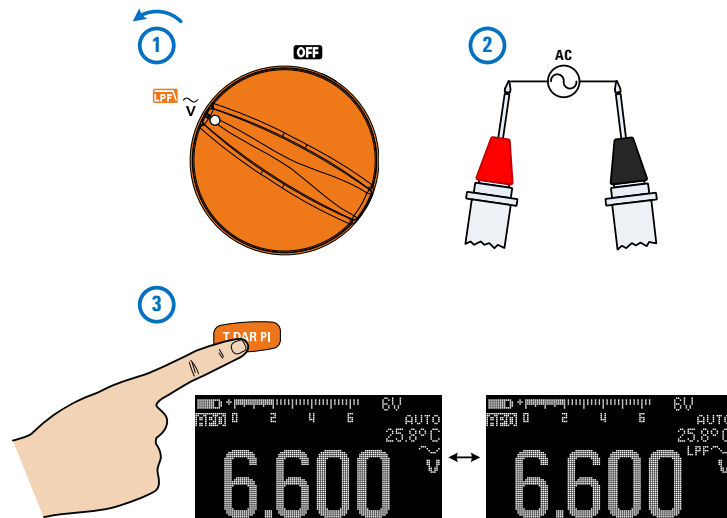

Figure 2-12 AC voltage with LPF measurement example

## 2 Making Measurements

### Measuring AC or DC Voltage

#### **WARNING**

- **To avoid possible electric shock or personal injury, do not use the LPF option to verify the presence of hazardous voltages. Voltages greater than what is indicated may be present. First, make a voltage measurement without the filter to detect the possible presence of hazardous voltages. Then, select the filter option.**
  - **When the LPF option is selected, the measurement function will switch to the manual range mode (defaults to 600 V) for variable speed drive (VSD) applications. It is recommended only to use 600 V and 1000 V in the manual range for VSD testing.**
- 

The low-pass filter can improve measurement performance on composite sine waves that are typically generated by inverters and variable frequency motor drives.

## Enabling the LPF in the Setup

You can also enable the low-pass filter to block and attenuate AC signals above 1 kHz for the AC or DC paths of V, mV, and  $\mu$ A mA measurements. See “Enabling the low-pass filter” on page 140 for more information.

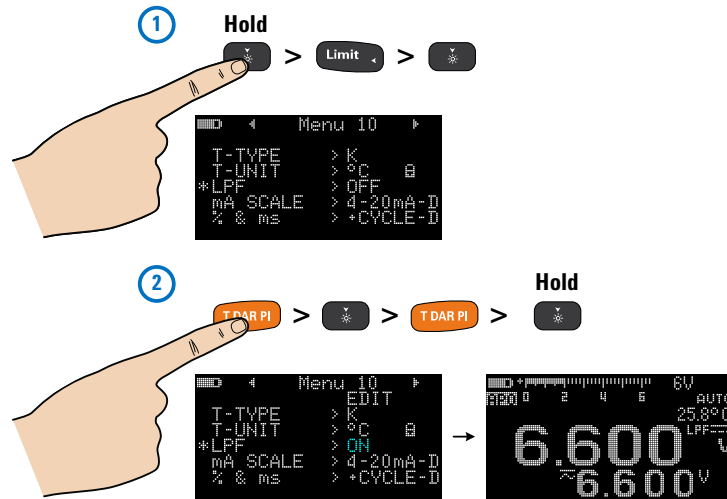

**Figure 2-13** Enabling the low-pass filter



## 2 Making Measurements

Measuring AC or DC Current

# Measuring AC or DC Current

Set up your tester to measure AC or DC current as shown in [Figure 2-14](#). Open the circuit path to be tested.

**Table 2-5** AC and DC current measurement positions

Legend	Default function		Function when  is pressed	
Rotary switch position	Primary display	Secondary display	Primary display	Secondary display
 Auto μA mA	Auto (μA mA)	AC+DC (μA mA)	<i>Cycles between</i>	
			1 DC (μA mA)	1 AC+DC (μA mA)
			2 AC (μA mA)	2 AC+DC (μA mA)
			3 % Scale of 4-20 mA	3 DC mA
			4 Auto (μA mA)	4 AC+DC (μA mA)

### WARNING

Never measure voltage by the current measurement terminals and never attempt an in-circuit current measurement where the open-circuit potential to earth is greater than 1000 V. Doing so will cause damage to the tester and possible electric shock or personal injury.

### CAUTION

To measure current, you must turn off power to the circuit and discharge all high-voltage capacitors. Then, open the circuit under test, and place the tester in series with the circuit. Insert the black test lead into the **COM** terminal and insert the red test lead to the **μA mA** terminal. Never place the probes across (in parallel with) any circuit or component when the leads are plugged into the current terminals.

### NOTE

Reversing the leads will produce a negative reading, but it will not damage the tester. Check the tester's fuses when no current is measured.

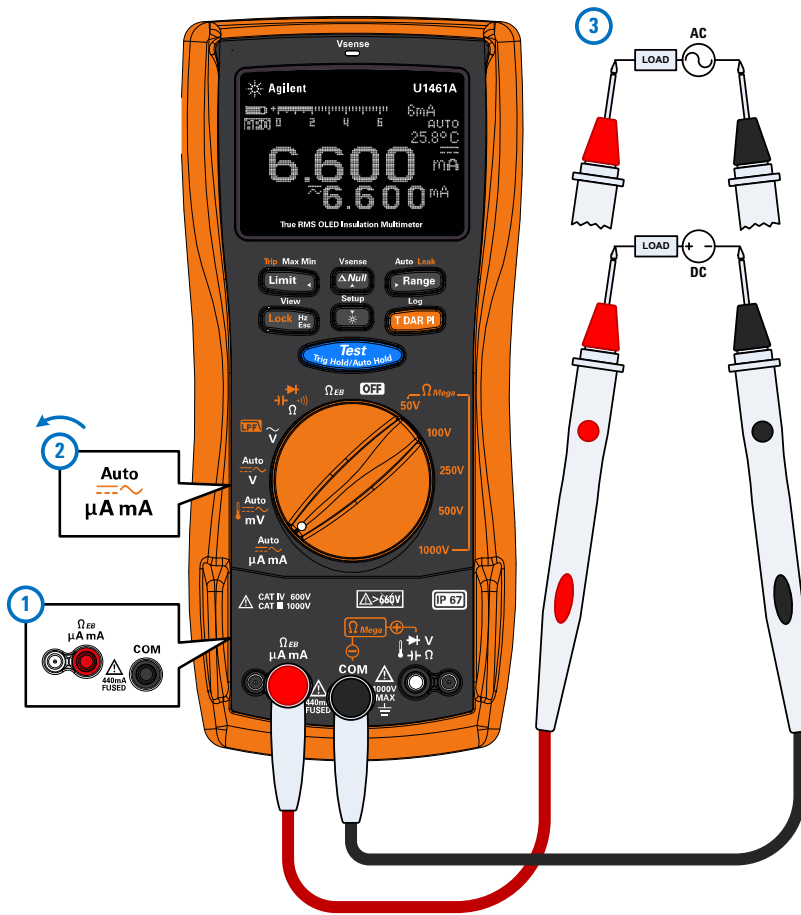

Figure 2-14 AC or DC current measurement example

**CAUTION**

Placing the probes across (in parallel with) a powered circuit when a lead is plugged into a current terminal can damage the circuit you are testing and blow the tester's fuse. This happens because the resistance through the tester's current terminals are very low, resulting in a short circuit.

## 2 Making Measurements

### Measuring AC or DC Current

#### NOTE

- Press  to measure the frequency of the AC or DC current source. See “[Measuring Frequency](#)” on page 63 to learn more.
- The **Auto** function is able to automatically identify the signal component (AC or DC) of an electrical source. See “[Auto AC or DC signal identification](#)” on page 56 to learn more.

## % Scale of 4-20 mA or 0-20 mA

To display the current measurement in % scale, set up your tester to measure DC current as shown in [Figure 2-14](#), then press  until the % scale is shown.

#### NOTE

- The 4-20 mA current loop output from a transmitter is a type of electrical signal that is used in a series circuit to provide a robust measurement signal that is proportional to the applied pressure, temperature, or flow in process control. The signal is a current loop where 4 mA represents the zero percent signal and 20 mA represents the 100 percent signal.
- The % scale for 4-20 mA or 0-20 mA in this tester is calculated using its corresponding DC mA measurement. The tester will automatically optimize the best resolution for the selected measurement. Two ranges are available for the % scale as shown in [Table 2-6](#).

The analog bar graph displays the current measurement value. (In the example above, 24 mA is represented as 125% in the 4-20 mA % scale.)

**Table 2-6** % Scale measurement range

% Scale of 4-20 mA or 0-20 mA	DC mA measurement range
999.99%	6 $\mu$ A or 600 mA <sup>[1]</sup>
9999.9%	

[1] Applies to both autoranging and manual range selection.







You can change the % scale range (4-20 mA or 0-20 mA) in the Setup ([page 141](#)). Use the % scale with a pressure transmitter, a valve positioner, or other output actuators to measure pressure, temperature, flow, pH, or other process variables.



## Measuring Frequency

Your tester allows simultaneous monitoring of real-time voltage or current with frequency measurements. To measure frequency, rotate the switch to one of the positions highlighted in [Table 2-7](#) and set up the tester accordingly. Press . Probe the test points, and read the display.

**Table 2-7** Measurement positions allowing frequency measurements

Legend	Default function	
Rotary switch position	Primary display	Secondary display
 	AC V	-
	AC V	-
	Auto (V)	AC+DC V
	Auto (mV)	AC+DC mV
	Auto ( $\mu$ A mA)	AC+DC ( $\mu$ A mA)

### WARNING

Never measure the frequency where the voltage or current level exceeds the specified range. Manually set the voltage or current range if you want to measure frequencies below 20 Hz.

### NOTE

- Pressing  controls the input range of the primary function (voltage or ampere) and not the frequency range.
- To obtain the best measuring results for frequency measurements, please use the AC measuring path.

#### Frequency measurement techniques

- Measuring the frequency of a signal helps detect the presence of harmonic currents in neutral conductors and determines whether these neutral currents are the result of unbalanced phases or non-linear loads.
- Frequency is the number of cycles a signal completes each second. Frequency is defined as  $1/\text{Period}$ . Period is defined as the time between the middle threshold crossings of two consecutive, like-polarity edges, as shown in [Figure 2-15](#).
- The tester measures the frequency of a voltage or current signal by counting the number of times the signal crosses a threshold level within a specified period of time.
- If a reading shows as 0 Hz or is unstable, the input signal may be below or near the trigger level. You can usually correct these problems by manually selecting a lower input range, which increases the sensitivity of the tester.
- If a reading seems to be a multiple of what you expect, the input signal may be distorted. Distortion can cause multiple triggerings of the frequency counter. Selecting a higher voltage range might solve this problem by decreasing the sensitivity of the tester. In general, the lowest frequency displayed is the correct one.
- The frequency of the input signal is shown in the primary display. The voltage or ampere value of the signal is shown in the secondary display. The bar graph does not indicate frequency but indicates the voltage or ampere value of the input signal.

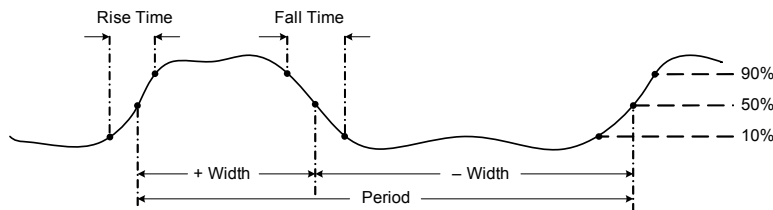



**Figure 2-15** Definition of frequency

## Measuring duty cycle and pulse width

You must first enable the duty cycle and pulse width display in the Setup menu. See “[Enabling the \(+ or -\) duty cycle and pulse width display](#)” on page 141 for more information.

While displaying voltage or current frequency, press  to select the measurement as a percentage (%) for duty cycle or in the millisecond (ms) unit for pulse width.



### NOTE

- The duty cycle (or duty factor) of a repetitive pulse train is the ratio of the positive or negative pulse width to the period expressed as a percentage. The duty-cycle function is optimized for measuring the on or off time of logic and switching signals. Systems such as electronic fuel injection systems and switching power supplies are controlled by pulses of varying width, which can be checked by measuring the duty cycle.
- The pulse width function measures the amount of time a signal is high or low. It is the time from the middle threshold of the rising edge to the middle threshold of the next falling edge. The measured waveform must be periodic; its pattern must repeat at equal time intervals.
- The bar graph does not indicate duty cycle or pulse width value but indicates the voltage or ampere value of the input signal.
- The duty cycle polarity is displayed to the left of the duty cycle value.  indicates a positive pulse width and  indicates a negative pulse width. Change the polarity in the Setup (see [page 141](#)).

## Measuring Resistance

Set up your tester to measure resistance as shown in Figure 2-16.

**Table 2-8** Resistance measurement position

Legend	Default function		Function when  is pressed	
	Primary display	Secondary display	Primary display	Secondary display
	Resistance	-	<i>Cycles between</i>	
			1 Continuity 2 Diode 3 Capacitance 4 Resistance	1 - 2 - 3 Cable length 4 -

**CAUTION**

To avoid possible damage to your tester or to the equipment under test, disconnect the circuit power and discharge all high-voltage capacitors before measuring resistance.

**NOTE**

Resistance (opposition to the current flow) is measured by sending a small current out through the test leads to the circuit under test. Because this current flows through all possible paths between the leads, the resistance reading represents the total resistance of all paths between the leads. Resistance is measured in ohms ( $\Omega$ ).

Keep the following in mind when measuring resistance.



- The test leads can add 0.1  $\Omega$  to 0.2  $\Omega$  of error to resistance measurements. To test the leads, touch the probe tips together and read the resistance of the leads. To remove lead resistance from the measurement, hold the test lead tips together and press . Now the resistance at the probe tips will be subtracted from all future display readings.
- Because the tester's test current flows through all possible paths between the probe tips, the measured value of a resistor in a circuit is often different from the resistor's rated value.
- The resistance function can produce enough voltage to forward-bias silicon diode or transistor junctions, causing them to conduct. If this is suspected, press  to apply a lower current in the next higher range.





Figure 2-16 Resistance measurement example

## Continuity Test

Set up your tester to perform continuity tests as shown in [Figure 2-17](#). The beeper will sound and the red LED lights up as a continuity indication.

**Table 2-9** Continuity test position

Legend	Default function		Function when  is pressed			
Rotary switch position	Primary display	Secondary display	Primary display	Secondary display		
	Resistance	-	<i>Cycles between</i>			
			1	Continuity	1	-
			2	Diode	2	-
			3	Capacitance	3	Cable length
4	Resistance	4	-			

**CAUTION**

To avoid possible damage to your tester or to the equipment under test, disconnect the circuit power and discharge all high-voltage capacitors before testing for continuity.

**NOTE**

- Continuity is the presence of circuit continuities. The beeper sounds as the resistance falls down to the threshold, and the red LED indicator will be lit (if enabled in the Setup). The audible and visual alert allows you to perform quick continuity tests without having to watch the display.
- The continuity function detects intermittent shorts and opens lasting as short as 1 ms. A brief short causes the tester to emit a short beep.
- You can enable or disable the audible alert via the Setup. See [“Changing the continuity alert”](#) on page 124 for more information on the audible alert option.

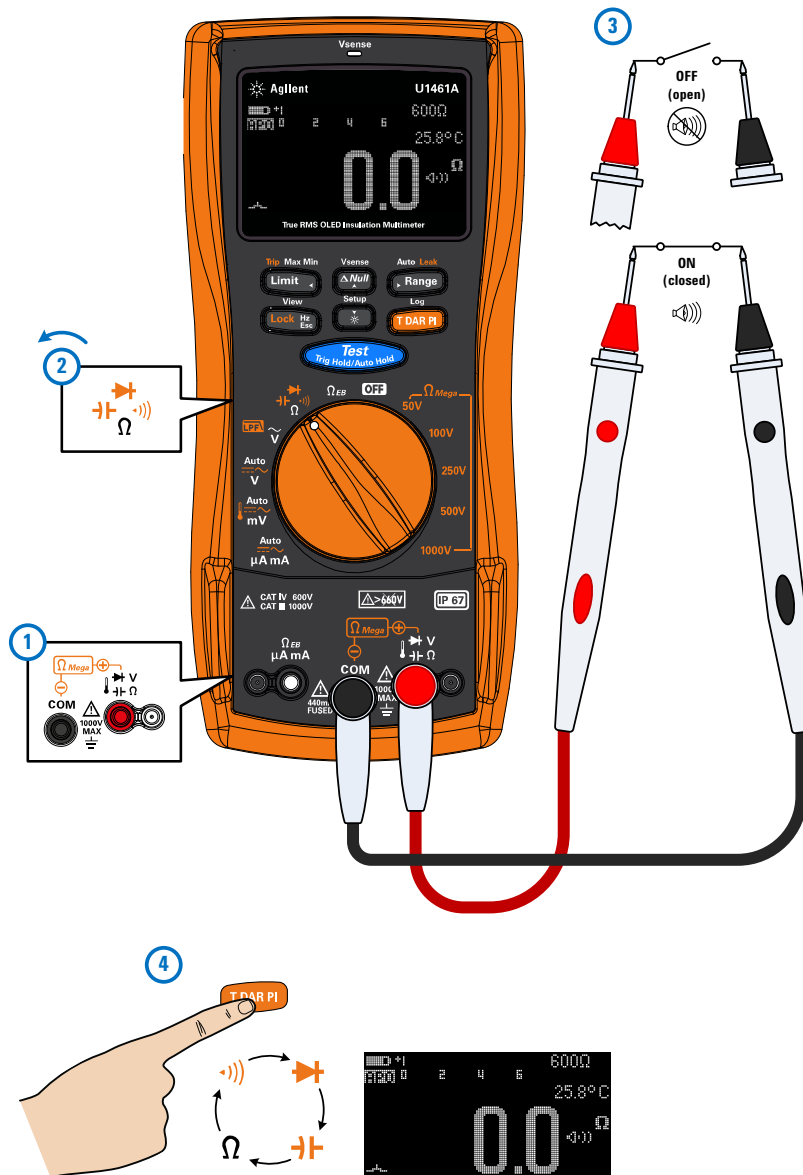



Figure 2-17 Continuity test example

## Diode Test

Set up your tester to perform diode tests as shown in [Figure 2-18](#).

**Table 2-10** Diode test position

Legend	Default function		Function when  is pressed	
	Primary display	Secondary display	Primary display	Secondary display
	Resistance	-	<i>Cycles between</i>	
			1 Continuity	1 -
			2 Diode	2 -
			3 Capacitance	3 Cable length
			4 Resistance	4 -

### CAUTION

To avoid possible damage to your tester or to the equipment under test, disconnect the circuit power and discharge all high-voltage capacitors before testing diodes.

### NOTE

- This test sends a current through a semiconductor junction, and then measures the junction’s voltage drop. A typical junction drops 0.3 V to 0.8 V.
- Connect the red test lead to the positive terminal (anode) of the diode and the black test lead to the negative terminal (cathode). The cathode of a diode is indicated with a band.
- Your tester can display diode forward-bias of up to approximately 1 V. The forward-bias of a typical diode is within the range of 0.3 V to 0.8 V; however, the reading can vary depending on the resistance of other pathways between the probe tips.
- If the beeper is enabled during diode test, the tester will beep briefly for a normal junction and sound continuously for a shorted junction, below  $0.04 \pm 0.02$  V approx. See [“Changing the beep frequency”](#) on page 115 to disable the beeper.



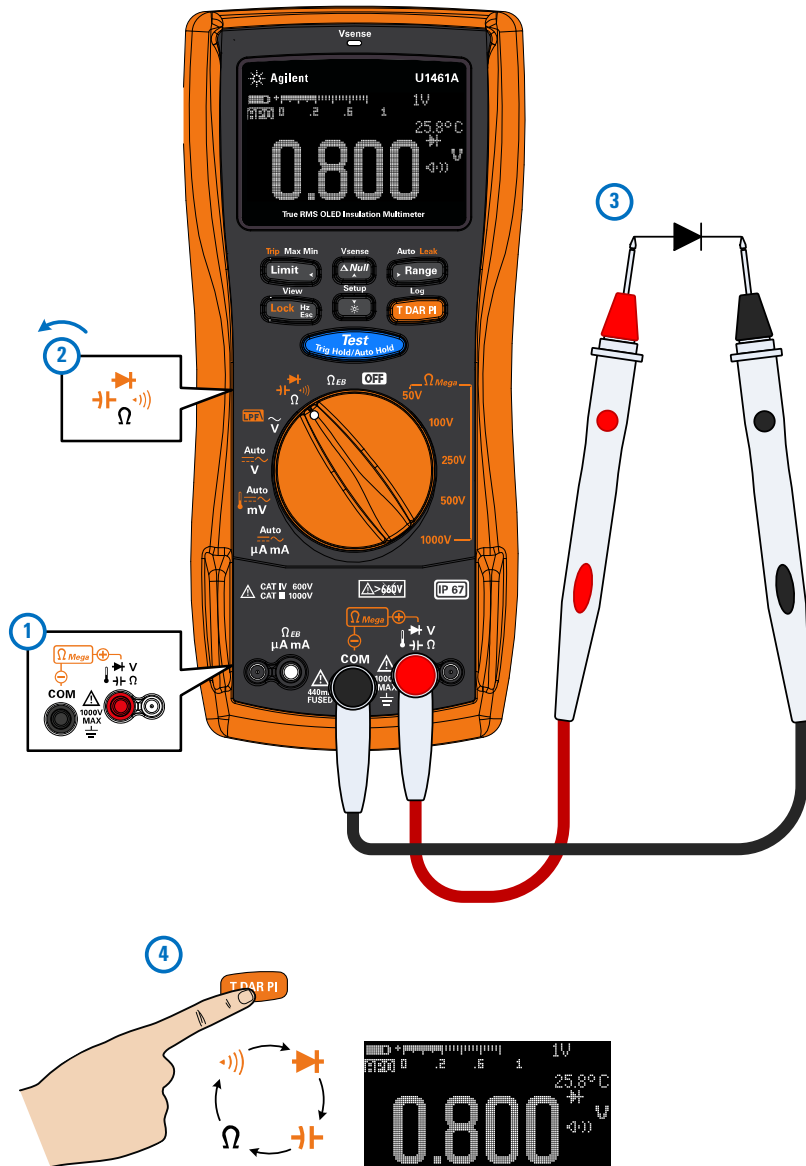
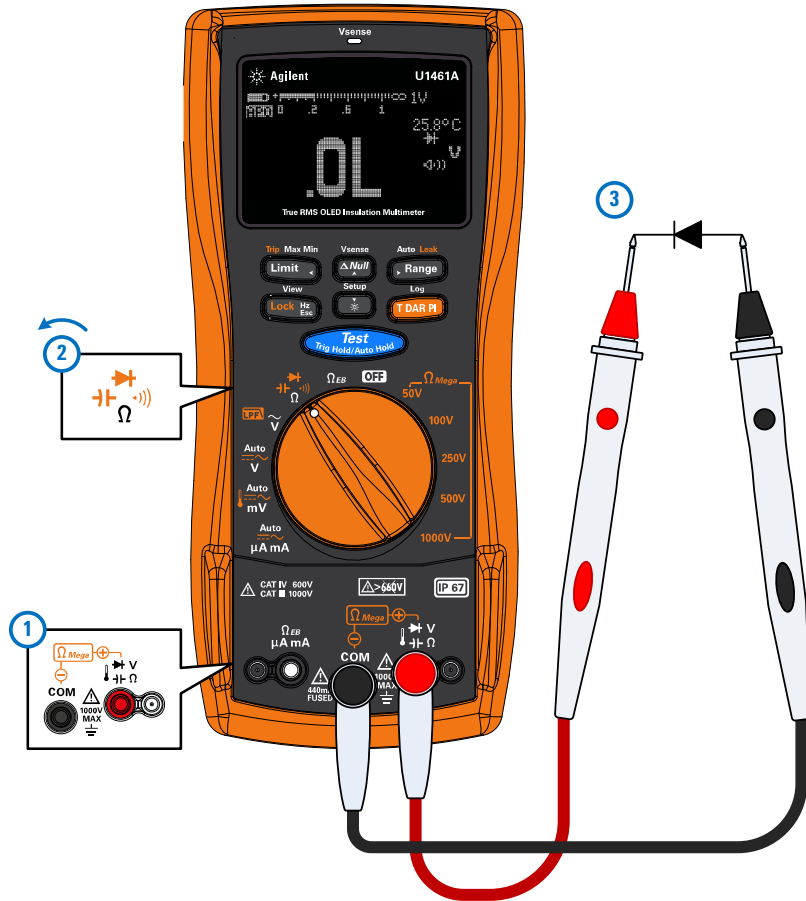

Figure 2-18 Forward-bias diode test example

## 2 Making Measurements

### Diode Test

Reverse the probes (as shown in [Figure 2-19](#)) and measure the voltage across the diode again.



**Figure 2-19** Reverse-bias diode test example

### Assessing the diode condition

Assess the diode according to the following guidelines:

- A diode is considered good if the tester displays **OL** in reverse-bias mode.
- A diode is considered shorted if the tester displays approximately 0 V in both forward- and reverse-bias modes, and the tester beeps continuously.
- A diode is considered open if the tester displays **OL** in both forward- and reverse-bias modes.

Use the diode test to check diodes, transistors, silicon controlled rectifiers (SCRs), and other semiconductor devices. A good diode allows current to flow in one direction only.

### Using the Auto-diode feature

Set up your tester to test diodes as shown in [Figure 2-18](#) or [Figure 2-19](#). Press and hold  to toggle the Auto-diode feature. Probe the test points, and read the display.

**NOTE**

The auto-diode function will help you test both forward- and reverse-bias directions simultaneously. You do not need to change the measuring direction to identify the diode's condition.

**Table 2-11** Auto-diode voltage thresholds

Forward voltage		Reverse voltage		Diode status	
Primary display		Secondary display		GO	NG
OL or <0.3 V or >0.8 V		-OL or >-0.3 V or <-0.8 V			<b>x</b>
Within 0.3 V to 0.8 V		-OL		✓	
OL		Within -0.3 V to -0.8 V		✓	

## 2 Making Measurements

### Diode Test

#### NOTE

The open condition will not be alerted as **OL** on both directions if the auto-diode function is used.

The primary display shows the forward-bias voltage value. The reverse-bias voltage value is shown in the secondary display.

- **GO** is shown briefly (along with a single beep) if the diode is in a good condition.
- **NG** is shown briefly (along with two beeps) if the diode is out of the thresholds.

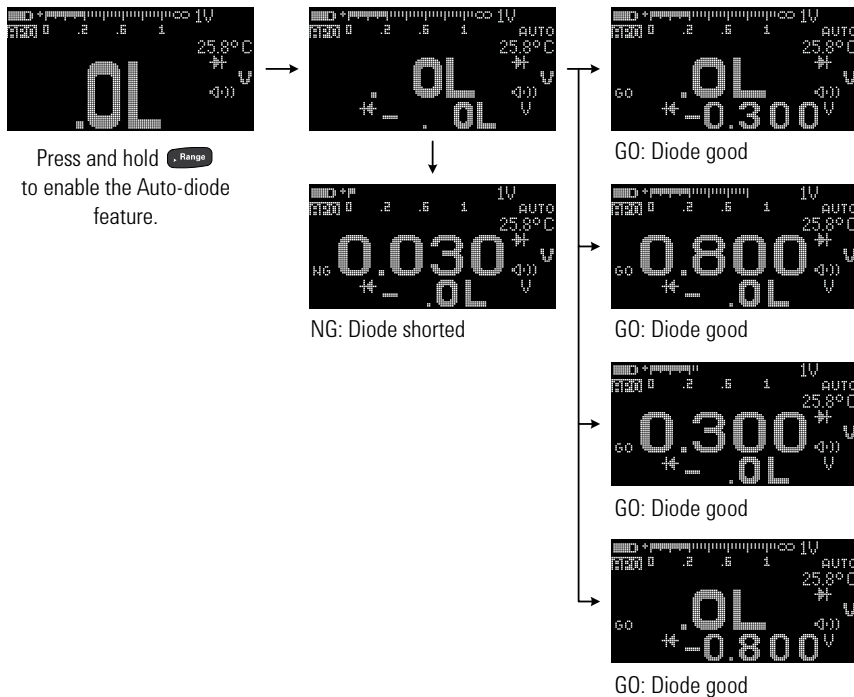



**Figure 2-20** Auto-diode operation

## Measuring Capacitance

Set up your tester to measure capacitance as shown in [Figure 2-21](#).



**Table 2-12** Capacitance measurement position

Legend	Default function		Function when  is pressed	
	Primary display	Secondary display	Primary display	Secondary display
	Resistance	-	<i>Cycles between</i>	
			1 Continuity 2 Diode 3 Capacitance 4 Resistance	1 - 2 - 3 Cable length 4 -

### CAUTION

To avoid possible damage to the tester or to the equipment under test, disconnect circuit power and discharge all high-voltage capacitors before measuring capacitance. Use the DC voltage function to confirm that the capacitor is fully discharged.

### NOTE

- The tester measures capacitance by charging the capacitor with a known current for a known period of time, measuring the resulting voltage, and then calculating the capacitance.
-  is shown on the bottom left of the display when the capacitor is charging, and  is shown when the capacitor is discharging.
- To improve measurement accuracy of small value capacitors, press  with the test leads open to subtract the residual capacitance of the tester and leads.
- For measuring capacitance values greater than 1000  $\mu\text{F}$ , discharge the capacitor first, then select a suitable range for measurement. This will speed up the measurement time and also ensure that the correct capacitance value is obtained.

## 2 Making Measurements

### Measuring Capacitance

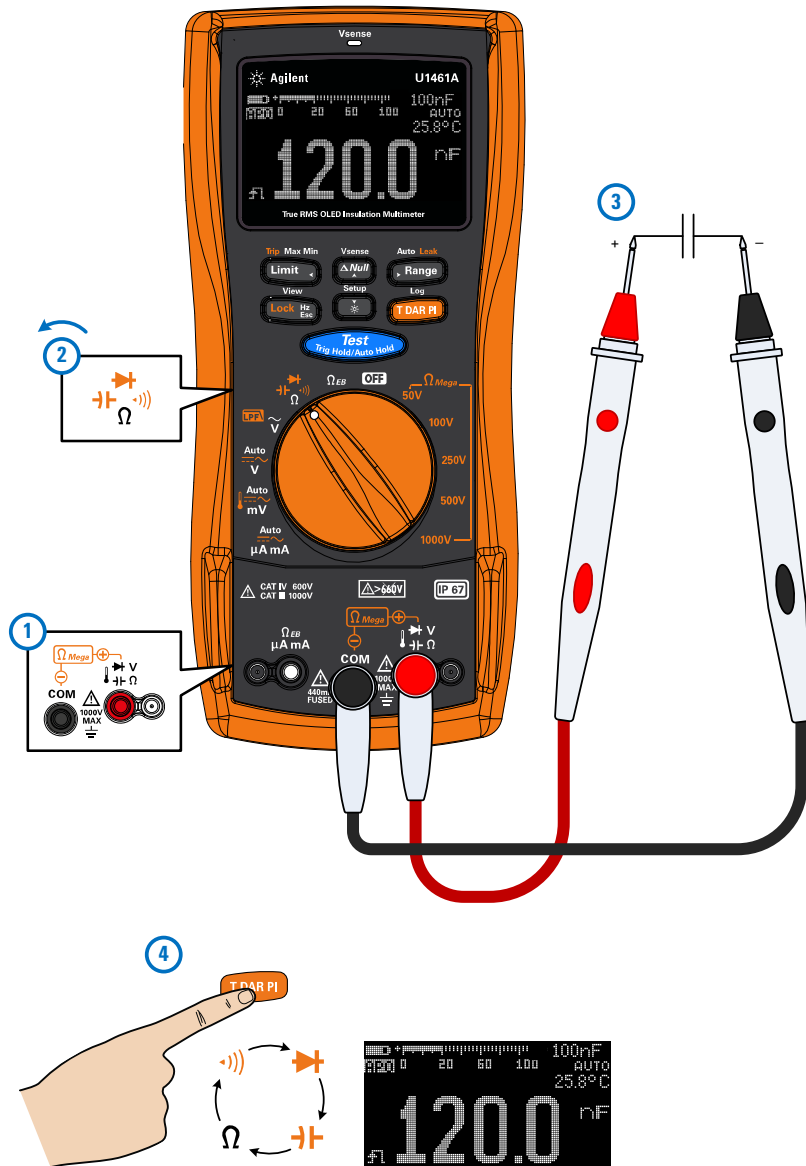

Figure 2-21 Capacitance measurement example

## Viewing the cable length value

Press **Lock Hz Esc** to temporarily display the cable length of the circuit under test in the secondary display.





The default cable length scale is 1 km per 40 nF (km/C). To change this value, see [“Changing the cable length scale”](#) on page 127.

You can also change the cable length unit (Meter or Feet). To change this value, see [“Changing the cable length unit”](#) on page 128.

## Measuring Temperature

The tester uses a type-K (default setting) temperature probe for measuring temperature. To measure temperature, set up your tester as shown in [Figure 2-22](#).

**Table 2-13** Temperature measurement position

Legend	Default function		Function when  is pressed	
Rotary switch position	Primary display	Secondary display	Primary display	Secondary display
	Auto (mV)	AC+DC mV	<i>Cycles between</i>	
			1 DC mV	1 AC+DC mV
			2 AC mV	2 AC+DC mV
			3 Temperature	3 -, °C, or °F
			4 Auto (mV)	4 AC+DC mV

### WARNING

**Do not connect the thermocouple to electrically live circuits. Doing so will potentially cause fire or electric shock.**

### CAUTION

Do not bend the thermocouple leads at sharp angles. Repeated bending over a period of time can break the leads.

### NOTE

- Shorting the  terminal to the **COM** terminal will display the temperature at the tester's terminals.
- To change the default thermocouple type from type-K to type-J, see [“Changing the thermocouple type”](#) on page 139 for more information.

The primary display normally shows temperature or the message **OL** (open thermocouple). The open thermocouple message may be due to a broken (open) probe or because no probe is installed into the input jacks of the tester.





**NOTE**

The bead-type thermocouple probe is suitable for measuring temperatures from  $-40\text{ }^{\circ}\text{C}$  to  $204\text{ }^{\circ}\text{C}$  ( $399\text{ }^{\circ}\text{F}$ ) in PTFE-compatible environments. Do not immerse this thermocouple probe in any liquid. For best results, use a thermocouple probe designed for each specific application — an immersion probe for liquid or gel, and an air probe for air measurement.

Observe the following measurement techniques:

- Clean the surface to be measured, and ensure that the probe is securely touching the surface. Remember to disable the applied power.
- When measuring above ambient temperatures, move the thermocouple along the surface until you get the highest temperature reading.
- When measuring below ambient temperatures, move the thermocouple along the surface until you get the lowest temperature reading.
- Place the tester in the operating environment for at least 1 hour as the tester is using a non-compensation transfer adapter with miniature thermal probe.

For quick measurement, use the  compensation to view the temperature variation of the thermocouple sensor. The  compensation assists you in measuring relative temperature immediately.

---

### Changing the temperature unit

Press  to change the temperature units between  $^{\circ}\text{C}$  or  $^{\circ}\text{F}$  (you must first change the temperature unit to switch between  $^{\circ}\text{C}$  and  $^{\circ}\text{F}$  or  $^{\circ}\text{F}$  and  $^{\circ}\text{C}$ ). See “[Changing the temperature unit](#)” on page 139 for more information.

**CAUTION**

The option to change the temperature unit is locked for certain regions. Always set the temperature unit display per the official requirements and in compliance with the National laws of your region.

---

## 2 Making Measurements

### Measuring Temperature

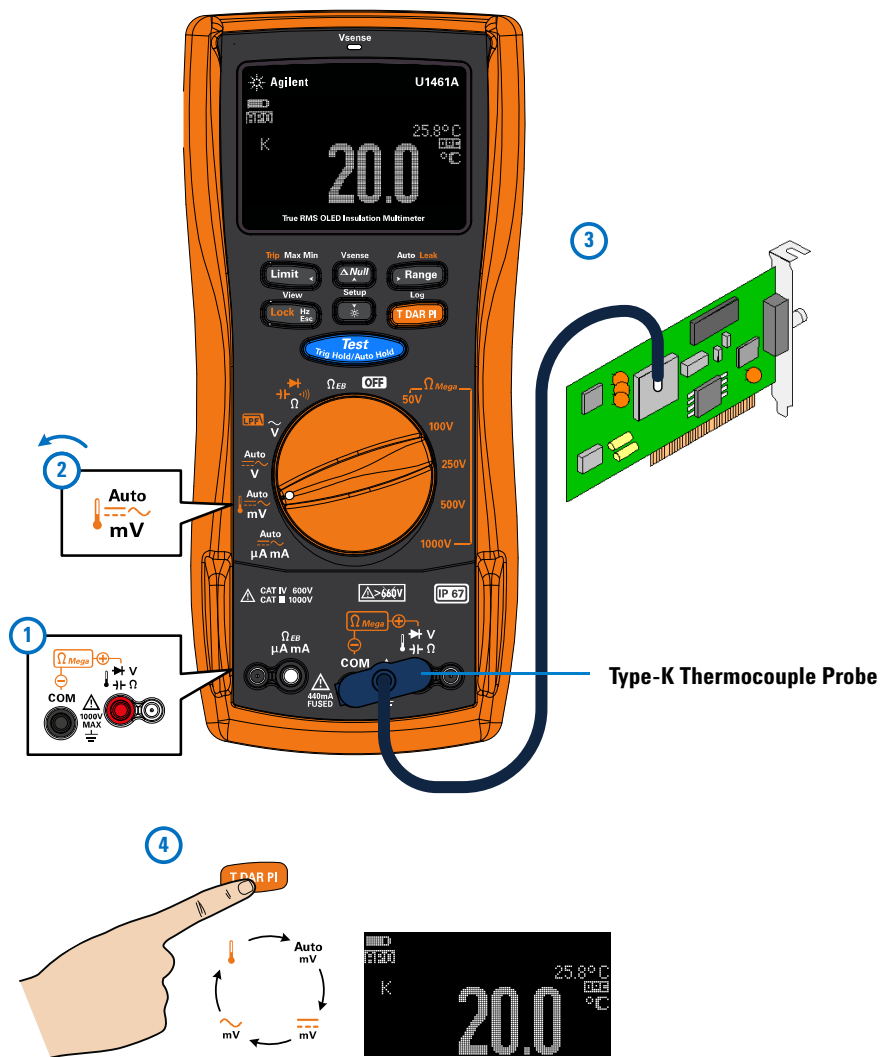



Figure 2-22 Surface temperature measurement example

### Temperature measurement without ambient compensation

If you are working in a constantly varying environment, where ambient temperatures are not constant, do the following:

- 1 Press **Range** for more than 1 second to select  compensation. This allows a quick measurement of the relative temperature.
- 2 Avoid contact between the thermocouple probe and the surface to be measured.
- 3 After a constant reading is obtained, press **ΔNull** to set the reading as the relative reference temperature.
- 4 Touch the surface to be measured with the thermocouple probe and read the display.

## 2 Making Measurements

Measuring Temperature

**THIS PAGE HAS BEEN INTENTIONALLY LEFT BLANK.**



## 3 Tester Features

Non-Contact AC Voltage Detection (Vsense)	84
Making Relative Measurements (Null)	86
Capturing Maximum and Minimum Values (Max Min)	87
Freezing the Display (TrigHold and AutoHold)	89
Performing Limit Comparisons (Limit)	90
Recording Measurement Data (Log)	92
Performing manual logs (HAND)	93
Performing interval logs (AUTO)	93
Performing event logs (TRIG)	94
Reviewing Previously Recorded Data (View)	97

The following sections describe the additional features available in your tester.



### 3 Tester Features

#### Non-Contact AC Voltage Detection (Vsense)

## Non-Contact AC Voltage Detection (Vsense)

For model U1461A only: Vsense is a non-contact voltage detector that detects the presence of AC voltages nearby.

### WARNING

- **You are advised to test on a known live circuit within the rated AC voltage range of this product before and after each use to ensure that Vsense works.**
- **Voltage could still be present even if there is no Vsense alert indication. Do not rely on Vsense with shielded wires. Never touch live voltage or conductor without the necessary insulation protection or power off the voltage source.**
- **Vsense may be affected by differences in socket design, insulation thickness, and insulation type.**

### CAUTION



You are advised to measure voltage by using test leads through the voltage measurement function after using Vsense, even if there is no alert indication.

- 1 Press and hold  to enable Vsense (on any position of the rotary switch except **OFF**).

### NOTE

If the presence of AC voltage is sensed, the tester will beep and the Vsense red LED at the top of the tester will turn on. The audible and visual alert allows you to easily sense nearby AC voltage presence.

**No resolution and accuracy of voltage measurement will be displayed in this mode.**

- 2 Press  to toggle the Vsense's sensitivity between **HIGH SENSE** (high sensitivity) or **LOW SENSE** (low sensitivity).
- 3 Press and hold  again to disable Vsense.

**NOTE**

Place the top of the tester close to a conductor when sensing for AC voltages (as low as 24 V in the high sensitivity setting). The high sensitivity setting allows for AC voltage sensing on other styles of recessed power connectors or sockets where the actual AC voltage is recessed within the connector itself. The low sensitivity setting can be used on flush mounted wall sockets or outlets and various power strips or cords.

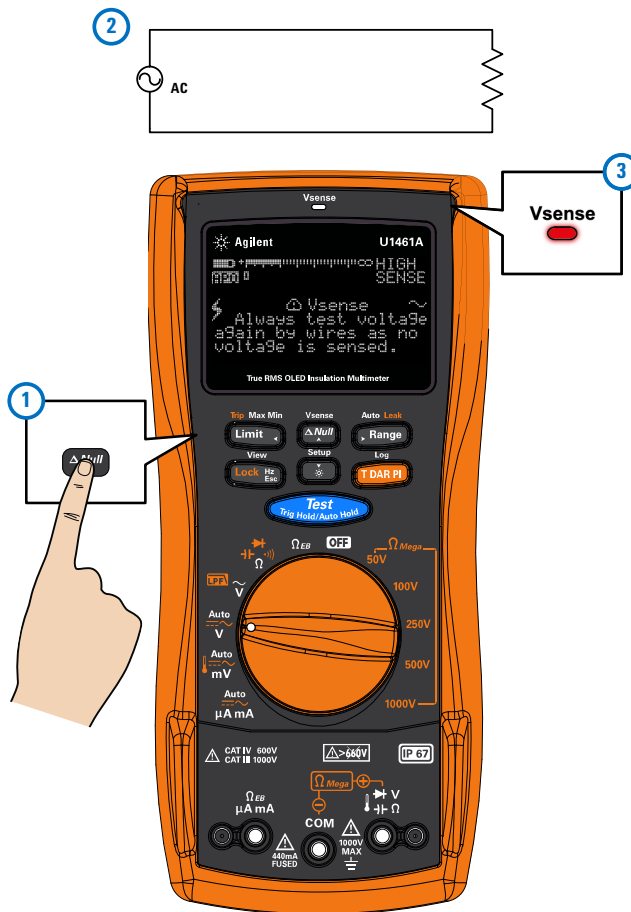

**Figure 3-1** Detecting AC voltage example

### 3 Tester Features

#### Making Relative Measurements (Null)

## Making Relative Measurements (Null)



When making null measurements, also called relative, each reading is the difference between a stored (selected or measured) null value and the input signal.

One possible application is to increase the accuracy of a resistance measurement by nulling the test lead resistance.





#### NOTE

Null can be set for both auto and manual range settings, but not in the case of an overload.

- 1 To activate Null, press . The measurement value at the time that when Null ( $\Delta$ NULL) is enabled, is stored as the reference value.
- 2 Press  again to view the stored reference value ( $\Delta$ BASE). The display will return to normal after 3 seconds.
- 3 To disable Null, press  while the stored reference value is shown (step 2).

For any measurement function, you can directly measure and store the null value by pressing  with the test leads open (nulls the test lead capacitance), shorted (nulls the test lead resistance), or across a desired null value circuit.

#### NOTE

- In resistance measurement, the tester will read a non-zero value even when the two test leads are in direct contact because of the resistance of these leads. Press  to zero-adjust the display.
- For DC voltage measurements, the thermal effect will influence the accuracy of the measurements. Short the test leads and press  when the displayed value is stable to zero-adjust the display.



## Capturing Maximum and Minimum Values (Max Min)

The Max Min operation stores the maximum, minimum, and average input values during a series of measurements.

When the input goes below the recorded minimum value or above the recorded maximum value, the tester beeps and records the new value. The elapsed time since the recording session was started is stored and shown on the display at the same time. The tester also calculates an average of all readings taken since Max Min was activated.



From the tester's display, you can view the following statistical data for any set of readings:

- **REC MAX:** highest reading since Max Min was enabled
- **REC MIN:** lowest reading since Max Min was enabled
- **REC AVG:** average or mean of all readings since Max Min was enabled
- **REC NOW:** present reading (actual input signal value)

- 1 Press and hold **Limit** to enable Max Min.
- 2 Press **Limit** again to cycle through the **MAX**, **MIN**, **AVG**, or **NOW** (present) input values.
- 3 The elapsed time is shown on the display. Press **Test** to restart the recording session.
- 4 Press and hold **Limit** again to disable Max Min.

### 3 Tester Features

#### Capturing Maximum and Minimum Values (Max Min)

##### NOTE

- Changing the range manually will also restart the recording session.
- You can also use Max Min while measuring frequency (see “[Measuring Frequency](#)” on page 63). If the measured frequency shown is not reflected accurately, press  again to restart the recording session.
- If an overload is recorded, the averaging function will be stopped. **OL** is shown in place of the average value.
- The APO (auto power-off) function is disabled when Max Min is enabled.
- The maximum recording time is 99999 seconds (1 day, 3 hours, 46 minutes, 39 seconds). **OL** is shown if the recording exceeds the maximum time.

---

Max Min is useful for capturing intermittent readings, recording minimum and maximum readings unattended, or recording readings while equipment operation keeps you from observing the tester display.

The true average value displayed is the arithmetic mean of all readings taken since the start of recording. The average reading is useful for smoothing out unstable inputs, calculating power consumption, or estimating the percentage of time a circuit is active.

## Freezing the Display (TrigHold and AutoHold)

### TrigHold operation

Press  to freeze the display for any function, except for the  $\Omega$  Mega or the  $\Omega$  EB function.



#### NOTE

Pressing  when the rotary switch is in one of the  $\Omega$  Mega or the  $\Omega$  EB position will result in a test being performed instead.

### AutoHold operation

Press and hold  to activate AutoHold for any function, except for the  $\Omega$  Mega or the  $\Omega$  EB function.



#### NOTE

Pressing and holding  when the rotary switch is in one of the  $\Omega$  Mega or the  $\Omega$  EB position will result in a test being performed instead.

AutoHold monitors the input signal and updates the display and, if enabled, emits a beep, whenever a new stable measurement is detected. A trigger point is one that varies more than a selected adjustable (AutoHold threshold) variation count (default 500 counts based on **DDDD** option selected in Setup). Open lead conditions are not included in the update.

To change the default AutoHold threshold count see [“Changing the variation count”](#) on page 109 for more information.

#### NOTE

If the reading value is unable to reach a stable state, the reading value will not be updated.

### 3 Tester Features

#### Performing Limit Comparisons (Limit)

## Performing Limit Comparisons (Limit)

Limit is used to compare the test result with the chosen settling value. The default settling values are shown in the table below.







**Table 3-1** Hi/Lo default settling values

Function	Limit settling default value		Limit settling range	
	HI	LO	HI	LO
Voltage measurement	>+30 V	<-30 V	LO to +9999.9 V	-9999.9 V to HI
Voltage measurement (up to millivolts)	>+30 mV	<-30 mV	LO to +999.99 mV	-999.99 mV to HI
Temperature measurement	>+100°	<-100°	LO to +9999.9°	-9999.9° to HI
Resistance measurement	>+10 Ω	<+10 Ω	LO to +99.999 MΩ	-99.999 MΩ to HI
Capacitance measurement	>+10 nF	<+10 nF	LO to +9.9999 mF	-9.9999 mF to HI
Diode test	>+0.8 V	<+0.3 V	LO to +9.9999 V	-9.9999 V to HI
Earth-bond resistance test	>+10 Ω	<+10 Ω	LO to +99.999 kΩ	-99.999 kΩ to HI
Current measurement	>+30 mA	<+0 mA	LO to +999.99 mA	-999.99 mA to HI
Insulation resistance test	>+10 MΩ	<+10 MΩ	LO to +999.99 GΩ	-999.99 GΩ to HI
Frequency measurement	>+999.99 Hz	<+0 Hz	LO to +999.99 kHz	+000.00 Hz to HI
Pulse width measurement	>+000.50 ms	<+0 ms	LO to +9999.9 ms	+000.00 ms to HI
Duty cycle measurement	>+050.00%	<+0%	LO to +999.99%	+000.00% to HI

You can select four different modes for Limit:

Limit mode	GO	NG
LIMIT HI or LIMIT LO	LO limit < Reading < HI limit	Reading < LO limit, or Reading > HI limit
LIMIT H>	Reading > HI limit	Reading ≤ HI limit
LIMIT L<	Reading < LO limit	Reading ≥ LO limit

- 1 Press  to activate Limit.
- 2 Press  again to set the comparison value. Use the arrow keys to position the cursor and to change the value shown.
- 3 Position the cursor on the **HI** symbol to change the Limit mode.
- 4 Press  to save your changes (or press  to discard your changes).
- 5 If the new value is passed:
  - **GO** is shown briefly
  - A short beep tone is heard
- 6 If the new values is failed:
  - For **LIMIT HI** or **LIMIT LO** mode: **HI** or **LO** is shown briefly along with the fail cause
  - For **LIMIT H>** or **LIMIT L<** mode: **NG** is shown briefly
  - Three short beep tones are heard
  - The red LED lights up

#### NOTE

When the Limit feature is enabled for insulation resistance tests, the red LED indicator lights up accordingly to the changes in the limit values instead of blinking every 2 seconds.

## Recording Measurement Data (Log)

Log provides you with the convenience of recording test data for future review or analysis. Since data is stored in the nonvolatile memory, the data remains saved even when the tester is turned OFF or if the battery is replaced.

Log collects measurement information over a user-specified duration. There are three Log options that can be used to capture measurement data: manual (**HAND**), interval (**AUTO**), or event (**TRIG**).

- A manual log stores an instance of the measured signal each time you press and hold  (see [page 93](#)).
- An interval log stores a record of the measured signal at a user-specified interval (see [page 93](#)).
- An event log stores a record of the measured signal each time a trigger condition is satisfied (see [page 94](#)).

**Table 3-2** Log maximum capacity

Log option	Maximum capacity for saving
Manual ( <b>HAND</b> )	100
Interval ( <b>AUTO</b> )	3000
Event ( <b>TRIG</b> )	3000

### NOTE

Each recorded index includes two parameters: the primary display and the secondary display. Examples include IR-V or Hz-V.

Before starting a recording session, set up the tester for the measurements to be recorded.

To change the Log option see “[Changing the recording option](#)” on page 110 for more information.

See “[Reviewing Previously Recorded Data \(View\)](#)” on page 97 to review or erase the recorded entries.

## Performing manual logs (HAND)

Ensure that **HAND** is selected as the Log option in the Setup.

- 1 Press and hold  to store the present input signal value.

 and the log entry number are displayed. The display will return to normal after a short while (around 1 second).

- 2 Repeat [step 1](#) again to save the next input signal value.

The maximum number of readings that can be stored for the manual log is 100 entries. When all entries are occupied, **H : FULL** will be shown when you press and hold .



## Performing interval logs (AUTO)

Ensure that **AUTO** is selected as the Log option in the Setup.

The default recording interval duration is 1 second. To change the recording interval duration, see [“Changing the sample interval duration”](#) on page 110 for more information.

The duration set in the Setup will determine how long each recording interval takes. The input signal value at the end of each interval will be recorded and saved into the tester’s memory.

### Start the interval log mode

- 1 Press and hold  to start interval log mode.

 and the log entry number are displayed. Subsequent readings are automatically recorded into the tester’s memory at the interval specified in the Setup.

- 2 Press and hold  again to exit the interval log mode.



### 3 Tester Features

#### Recording Measurement Data (Log)

The maximum number of readings that can be stored for the interval log is 3000 entries. When all entries are occupied, **A:FULL** will be shown when you press and hold .

#### NOTE

When the interval log recording session is running, all other keypad operations are disabled; except for , which, when pressed for more than 1 second, will stop and exit the recording session. Furthermore, APO (auto power-off) is disabled during the recording session.

## Performing event logs (TRIG)

Ensure that **TRIG** is selected as the Log option in the Setup.

Event logs are used only with the following modes:



- TrigHold and AutoHold ([page 89](#))
- Max Min recordings ([page 87](#))
- Limit comparisons ([page 90](#))
- Earth-bond resistance tests ([page 51](#))
- Insulation resistance tests ([page 51](#))
- T/DAR/PI tests ([page 36](#))

Event records are triggered by the measured signal satisfying a trigger condition set by the measurement function used in the following modes (shown in [Table 3-3](#) on page 95):





**Table 3-3** Event log trigger conditions

Modes	Trigger condition	Primary display recorded	Secondary display recorded
	<i>The input signal value is recorded:</i>		
TrigHold	Each time you press  and the reading update is stable.	Voltage, current, resistance, capacitance, diode, or frequency	Voltage, current, capacitance cable length, or output source voltage
AutoHold	When the input signal varies more than the variation count and the reading update is stable.	Voltage, current, resistance, capacitance, diode, or frequency	Voltage, current, capacitance cable length, or output source voltage
Max Min	When a new maximum (or minimum) value is recorded. The average and present readings are not recorded in the Event log.	Voltage, current, resistance, capacitance, diode, or frequency	Voltage, current, capacitance cable length, or output source voltage
Limit	Each time a new value is compared ( <b>GO/NG/HI/LO</b> ).	Voltage, current, resistance, capacitance, diode, or frequency	Voltage, current, capacitance cable length, or output source voltage
Earth-bond resistance test	Each time you press  to stop the test output source.	Resistance or leak current value	Test output source voltage
Insulation resistance test			
T	When the time is up (Timer = 00:00), the final value is recorded before the test output source is stopped.	Resistance or leak current value	Test output source voltage

**NOTE**

The values of DAR t30 (or DAR t15), DAR t60, PI t1, and PI t10 will be recorded in every IR rotary switch location. For more information on DAR and PI tests, see [page 41](#) and [page 42](#).

### 3 Tester Features

#### Recording Measurement Data (Log)

##### Start the event log mode

1 Select one of the six modes listed in [Table 3-3](#).

2 Press and hold  to start event log mode.

 and the log entry number are displayed. The primary display and secondary display readings will be recorded into the memory. Subsequent readings are automatically recorded into the tester's memory every time the trigger condition specified in [Table 3-3](#) is satisfied.

3 Press and hold  again to exit the event log mode.



The maximum number of readings that can be stored for the event log is 3000 entries. When all entries are occupied, **E:FULL** will be shown when you press and hold .

#### NOTE

APO (auto power-off) is disabled during the recording session.







## Reviewing Previously Recorded Data (View)

Viewing data stored in the tester's memory is performed through the  key.

- 1 Press and hold  to View the previously recorded data. Press  again to cycle through the manual (H), interval (A), or event (E) records.



If nothing has been recorded, **H:Void**, **A:Void**, or **E:Void** will be displayed instead.

- 2 Select the desired recording category to view its entries.
  - i Press  to jump to the first stored entry. Press  to jump to the last stored entry.
  - ii Press  to view the next stored entry. The index number increases by one. Press  to view the previous stored entry. The index number decreases by one.
  - iii Press  to clear the last stored entry for the selected log type. Press and hold  to clear all entries for the selected log type.
- 3 Press and hold  again to exit the View mode.

### Sanitizing the Log Memories

You have the option to sanitize the log memories of your tester. This operation erases the log memories of your tester thoroughly. The data stored in the tester's memory will not be able to be reconstructed in any way after the data sanitization operation.



Prior to sanitizing the log memories, ensure that all manual (H), interval (A), or event (E) records have been cleared (see [step iii](#)). When all entries are cleared (**H:Void**, **A:Void**, and **E:Void**), press and hold  to sanitize the log memories.

#### CAUTION

The data sanitization operation may take up to 30 seconds to complete. Do not press any keys or turn the rotary switch until the data sanitization operation is completed.

### **3 Tester Features**

Reviewing Previously Recorded Data (View)

**THIS PAGE HAS BEEN INTENTIONALLY LEFT BLANK.**



## 4 Setup Options

Using the Setup Menu	100
Editing numerical values	101
Setup Menu Summary	102
Setup Menu Items	109
Menu 1	109
Menu 2	113
Menu 3	115
Menu 4	119
Menu 5	123
Menu 6	125
Menu 7	129
Menu 8	133
Menu 9	134
Menu 10	138

The following sections describe how to change the preset features of your tester.



















## Using the Setup Menu

The Setup menu allows you to change a number of nonvolatile preset features. Modifying these settings affects the general operation of your tester across several functions. Select a setting to edit to perform one of the following actions:

- Switch between two values, such as on or off.
- Cycle through multiple values from a predefined list.
- Decrease or increase a numerical value within a fixed range.

The contents of the Setup menu are summarized in [Table 4-2](#) on page 102.

**Table 4-1** Setup menu key functions

Legend	Description
	<ul style="list-style-type: none"> <li>• Press  for more than 1 second to access the Setup menu.</li> <li>• Press and hold  until the tester restarts to exit the Setup menu.</li> </ul>
	<ul style="list-style-type: none"> <li>• Arrow keys left and right</li> <li>• Press  or  to browse each menu page.</li> </ul>
	<ul style="list-style-type: none"> <li>• Arrow keys up and down</li> <li>• Press  or  at each menu page to move the cursor to a specific menu item.</li> </ul>
	<ul style="list-style-type: none"> <li>• Press  to edit the selected menu item. The menu item's value will flash to indicate that you can now change the value shown.</li> <li>• Press  or  again to switch between two values, to cycle through multiple values from a list, or to decrease or increase a numerical value.</li> <li>• Press  to save your changes.</li> </ul>
	<ul style="list-style-type: none"> <li>• While the menu item's value is flashing, press  to discard your changes.</li> </ul>

### NOTE

The tester will automatically exit the Setup menu after 30 seconds of inactivity.

## Editing numerical values

When editing numerical values, use the **Limit** and **Range** to position the cursor on a numerical digit.

- Press **Limit** to move the cursor to the left, and
- Press **Range** to move the cursor to the right.

When the cursor is positioned over a digit, use the **ΔNull** and **▽%** keys to change the numerical digit.

- Press **ΔNull** to increment the digit, and
- Press **▽%** to decrement the digit.

When you have completed your changes, save the new numerical value by pressing **T D A R M**. (Or alternatively, if you wish to discard the changes you made, press **Lock Hz Esc**.)

Press and hold **▽%** for more than 1 second to enter the Setup menu.

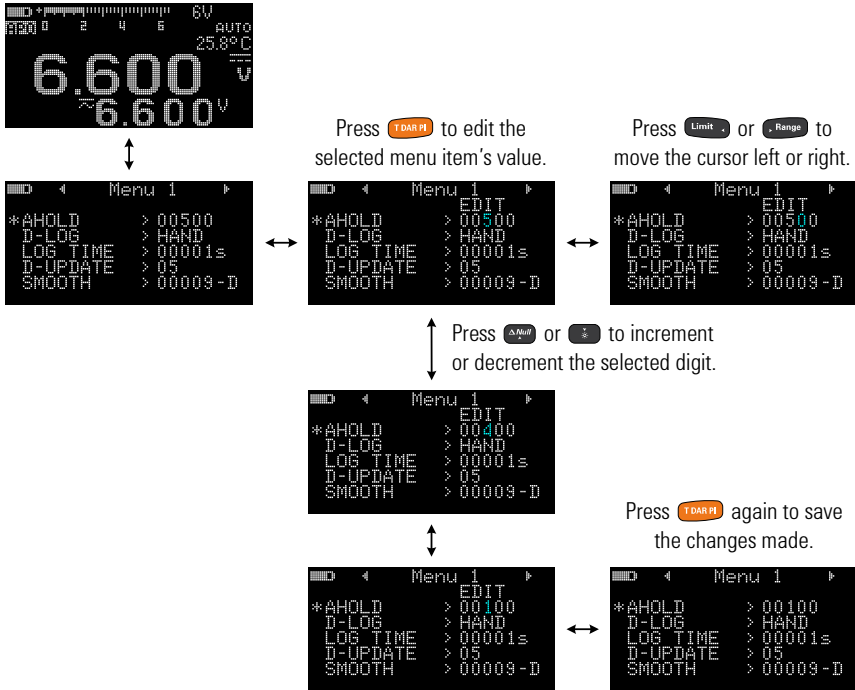

## Setup Menu Summary

The Setup menu items are summarized in the table below. Click the respective “Learn more” pages for more information on each menu item.

**Table 4-2** Setup menu item descriptions

Menu	Legend	Available settings	Description	Learn more on:
MENU 1	AHOLD	00500 to 99999	Set the AutoHold threshold count from 5 to 99999 counts (or 9999 counts, depending on the display count selected). Default is 500 counts.	<a href="#">page 109</a>
	D-LOG	HAND, AUTO, or TRIG	Set the data logging option (HAND: manual log, AUTO: interval log, or TRIG: event log). Default is manual log.	<a href="#">page 110</a>
	LOG TIME	00001 S to 99999 S	Set the logging duration for interval logs from 1 to 99999 seconds (1 day, 3 hours, 46 minutes, 39 seconds). Default is 1 second.	<a href="#">page 110</a>
	D-UPDATE	05, 10, 20, or 40 times per second	Set the data update rate for voltage, current, resistance, and diode measurements. Default is 5 times per second.	<a href="#">page 111</a>
	SMOOTH	00001 to 99999 (D or E)	Set the settling value from 00001 to 99999. You can also disable this feature (D). Default is disabled (00009-D).	<a href="#">page 112</a>



**Table 4-2** Setup menu item descriptions (continued)

<b>Menu</b>	<b>Legend</b>	<b>Available settings</b>	<b>Description</b>	<b>Learn more on:</b>
MENU 2	DMM COUNTS	DDDDD or DDDD	Set the voltage, current, and frequency display count. Default is DDDD	<a href="#">page 114</a>
	Cx COUNTS	DDDDD, DDDD, or DDD	Set the capacitance display count. Default is DDDD	<a href="#">page 114</a>
	Rx COUNTS	DDDDD, DDDD, or DDD	Set the resistance display count. Default is DDDD	<a href="#">page 114</a>
	EBR COUNTS	DDDD or DDD	Set the earth-bond resistance display count. Default is DDDD	<a href="#">page 114</a>
	IR COUNTS	DDDD or DDD	Set the insulation resistance display count. Default is DDD	<a href="#">page 114</a>
MENU 3	BEEP	3200 Hz to 4267 Hz, or OFF	Set the beep frequency from 3200 Hz to 4267 Hz. You can also disable this feature (off). Default is 3840 Hz.	<a href="#">page 115</a>
	APO	01 m to 99 m (E or D)	Set the auto power-off timer period from 1 to 99 minutes (1 hour, 39 minutes). You can also disable this feature (D). Default is 10 minutes (10 m-E).	<a href="#">page 116</a>
	BACKLIT	LOW, MEDIUM, HIGH, or AUTO-(01 to 99)	Set the default OLED behavior from low to high. You can also set the OLED to auto-dim (AUTO) and change the auto-dim settling time (1 to 99 seconds). Default is auto-dim (AUTO-90).	<a href="#">page 116</a>
	MELODY	FACTORY, USER, BEEE, or OFF	Set the power-on melody to the factory default, a beep, or disable this feature (off). Default is BEEE.	<a href="#">page 117</a>
	GREETING	FACTORY, USER, or OFF	Set the power-on greetings to the factory default or disable this feature (off). Default is FACTORY.	<a href="#">page 118</a>

## 4 Setup Options

### Setup Menu Summary

**Table 4-2** Setup menu item descriptions (continued)

Menu	Legend	Available settings	Description	Learn more on:
MENU 4	BAUD	9600 or 19200	Set the baud rate for remote communication with a PC (9600 or 19200). Default is 9600.	<a href="#">page 119</a>
	DATA BIT	7 or 8	Set the data bit length for remote communication with a PC (7-bit or 8-bit). Default is 8-bit.	<a href="#">page 120</a>
	PARITY	NONE, EVEN, or ODD	Set the parity bit for remote communication with a PC (none, even, or odd). Default is none.	<a href="#">page 120</a>
	ECHO	OFF or ON	Set the tester to echo (return) all the characters it receives. Default is disabled (off).	<a href="#">page 121</a>
	PRINT	OFF or ON	Set the tester to print out the measured data when the measuring cycle is completed. Default is disabled (off).	<a href="#">page 121</a>

**Table 4-2** Setup menu item descriptions (continued)

Menu	Legend	Available settings	Description	Learn more on:
MENU 5	REVISION	-	Displays the tester's firmware revision.	-
	S/N	-	Displays the tester's serial number (only the last eight digits).	-
	DUAL DC+AC	YES or NO	Enable dual display for voltage and current measurements. (AC+DC measurements are shown on the secondary display.) Default is yes.	<a href="#">page 123</a>
	ALERT HORN	BEE&LED, OFF&LED, BEE&OFF, OFF&OFF	Set the tester to beep momentarily and light up the red LED indicator for limit and continuity alerts. You can also disable either or both alerts (off). Default is to beep momentarily and light up the red LED indicator (BEE&LED).	<a href="#">page 124</a>
	CONTINUITY	SHORT, OPEN, or TONE (E or D)	Set the tester to sound a single beep or a tone during continuity alerts for short or open circuits. You can also disable this feature (D). Default is a single beep for short circuits (SHORT-E).	<a href="#">page 124</a>

## 4 Setup Options

### Setup Menu Summary

**Table 4-2** Setup menu item descriptions (continued)

Menu	Legend	Available settings	Description	Learn more on:
MENU 6	DEFAULT	YES or NO	Reset the tester to its factory default settings.	<a href="#">page 126</a>
	BATTERY	PRI or SEC	Change the battery selection from primary to secondary. Default is primary.	<a href="#">page 126</a>
	MIN-Hz	0.5 Hz or 10 Hz	Set the minimum measurement frequency (0.5 Hz or 10 Hz). Default is 0.5 Hz.	<a href="#">page 127</a>
	CABLE km/C	1 nF/km to 99 nF/km (E or D)	Set the capacitance measurement versus cable length scale from 1 to 99 nF/km. You can also disable this feature (D). Default is 40 nF/km (40nF-E).	<a href="#">page 127</a>
	CL-UNIT	Meter (m) or Foot (ft)	Set the cable length unit (Meter or Foot) for capacitance measurements. Default is Meter (m).	<a href="#">page 128</a>
MENU 7	mV INPUT	10 M $\Omega$ or >1 G $\Omega$	Set the input impedance for mV measurements. Default is 10 M $\Omega$ .	<a href="#">page 129</a>
	REMOTE KEY	K1 to K7 (D or E)	Change or disable the button operation on the remote probe. Default is  (K7-E).	<a href="#">page 130</a>
	LOCK ONCE	YES or NO	Enable or disable the lock once feature. Default is enabled (YES).	<a href="#">page 131</a>
	INHIBIT V	30 V, 50 V or 75 V	Set the maximum inhibit voltage for insulation resistance test. Default is 30 V.	<a href="#">page 131</a>
	DAR TIME	60:30 or 60:15 (seconds)	Set the Dielectric Absorption Ratio in seconds (60:30 or 60:15). Default is 60:30 (seconds).	<a href="#">page 132</a>

**Table 4-2** Setup menu item descriptions (continued)

Menu	Legend	Available settings	Description	Learn more on:
MENU 8	IR: 50 V	F 50 V or U (10 to 60) V	Set the insulation resistance test voltage to the factory default or user-defined. Default is factory.	<a href="#">page 133</a>
	IR: 100 V	F 100 V or U (10 to 120) V		
	IR: 250 V	F 250 V or U (10 to 300) V		
	IR: 500 V	F 500 V or U (10 to 600) V		
	IR: 1000 V	F 1000 V or U (10 to 1100) V		
MENU 9	TEST TIME	00:05 to 59:59	Set the insulation resistance or earth-bond resistance test period. Default is 1 minute (01:00)	<a href="#">page 135</a>
	SCAN TIME	1 to 99 (seconds)	Set the dwelling time for each step in the Scan function. Default is 10 seconds.	<a href="#">page 135</a>
	SCAN STEP	001 to 100	Set the number of steps for the Scan function. Default is 5 steps.	<a href="#">page 136</a>
	RAMP STEP	0001 to 1000	Set the number of steps for the Ramp function. Default is 100 steps.	<a href="#">page 137</a>
	TRIP mA	0.001 mA to 1.500 mA	Set the trip current level. Default is 1.000 mA.	<a href="#">page 137</a>

## 4 Setup Options

### Setup Menu Summary

**Table 4-2** Setup menu item descriptions (continued)

Menu	Legend	Available settings	Description	Learn more on:
MENU 10 <sup>[1]</sup>	T-TYPE	J or K	Set the thermocouple type (type J or type K) for temperature measurements. Default is type K.	<a href="#">page 139</a>
	T-UNIT	°C, °F/°C, °C/°F, or °F	Set the temperature unit (Celsius, Fahrenheit/Celsius, Celsius/Fahrenheit, or Fahrenheit) for temperature measurements. Default is °C (Celsius).	<a href="#">page 139</a>
	LPF	ON or OFF	Enable the low-pass filter to filter out higher frequencies with (AC/DC path) V, mV, $\mu$ A, or mA measurements. Default is off.	<a href="#">page 140</a>
	mA SCALE	0-20 mA or 4-20 mA (D or E)	Set the % scale selection (0-20 mA or 4-20 mA) for DC current measurements. You can also disable this feature (D). Default is disabled (4-20mA-D).	<a href="#">page 141</a>
	% & ms	+CYCLE-D	Set + or – cycle for duty cycle and pulse width measurements. You can also disable this feature (D). Default is disabled (+CYCLE-D).	<a href="#">page 141</a>

[1] Model U1461A only.

# Setup Menu Items

## Menu 1

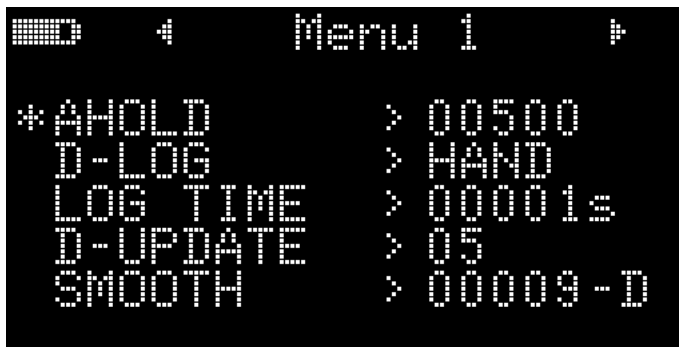





### Changing the variation count

Menu Items	Learn more on:
AHOLD	<a href="#">"Changing the variation count"</a> on page 109
D-LOG	<a href="#">"Changing the recording option"</a> on page 110
LOG TIME	<a href="#">"Changing the sample interval duration"</a> on page 110
D-UPDATE	<a href="#">"Changing the data update rate"</a> on page 111
SMOOTH	<a href="#">"Enabling smooth mode"</a> on page 112

This setting is used with the AutoHold feature (see [page 89](#)). When the variation of the measured value exceeds the value of the variation count, the AutoHold feature will be ready to trigger.

Parameter	Range	Default setting
AHOLD	(5 to 99999) counts	00500

To change the variation count:

- 1 Press  for more than 1 second to enter the Setup menu.
- 2 Browse to **Menu 1 > AHOLD**, and press  to edit the value.
- 3 Use the arrow keys to change the variation count.
- 4 Press  to save your changes (or press  to discard your changes).
- 5 Press and hold  until the tester restarts to return to normal operation.





### Changing the recording option

This setting is used with the Data Logging feature (see [page 92](#)). There are three available recording options for the Data Logging feature.

- HAND: Manual log
- AUTO: Interval log
- TRIG: Event log

Parameter	Range	Default setting
D-LOG	HAND, AUTO, or TRIG	HAND

To change the recording option:

- 1 Press  for more than 1 second to enter the Setup menu.
- 2 Browse to **Menu 1 > D-LOG**, and press  to edit the value.
- 3 Use the arrow keys to change the recording option.
- 4 Press  to save your changes (or press  to discard your changes).
- 5 Press and hold  until the tester restarts to return to normal operation.





### Changing the sample interval duration

This setting is used with the Interval Data Logging feature (see [page 93](#)). The tester will record a measurement value at the beginning of every sample interval.



Parameter	Range	Default setting
LOG TIME	(1 to 99999) s	00001 S

To change the sample interval duration:





- 1 Press  for more than 1 second to enter the Setup menu.
- 2 Browse to **Menu 1 > LOG TIME**, and press  to edit the value.
- 3 Use the arrow keys to change the sample interval duration.
- 4 Press  to save your changes (or press  to discard your changes).
- 5 Press and hold  until the tester restarts to return to normal operation.

### Changing the data update rate

This setting is used to increase the data update rate for voltage, current, resistance, and diode measurements.

Parameter	Range	Default setting
D-UPDATE	5, 10, 20, or 40 times per second	5 times per second

To change the data update rate:

- 1 Press  for more than 1 second to enter the Setup menu.
- 2 Browse to **Menu 1 > D-UPDATE**, and press  to edit the value.
- 3 Use the arrow keys to change the data update rate.
- 4 Press  to save your changes (or press  to discard your changes).
- 5 Press and hold  until the tester restarts to return to normal operation.

### Enabling smooth mode





Smooth is used to smoothen the refresh rate of the readings in order to reduce the impact of unexpected noise and to help you achieve a stable reading.

The smooth refresh rate can be set from 00001 to 99999. The smooth time is defined as the set value +1. Smooth will be restarted when the variation count is exceeded, when the range is changed, or after a tester function or feature is enabled. The variation count is set to the value used for the AutoHold feature (see “Changing the variation count” on page 109).

You can enable Smooth by holding  while turning on the tester (“Your Tester in Brief” on page 10). This method, however, is temporary and Smooth will be turned off when you cycle the tester’s power. You can permanently enable Smooth from the Setup menu.

Parameter	Range	Default setting
SMOOTH	<ul style="list-style-type: none"><li>• 00001 to 99999</li><li>• D(isabled) or E(nabled)</li></ul>	0009-D(isabled)

To change the smooth refresh rate:

- 1 Press  for more than 1 second to enter the Setup menu.
- 2 Browse to **Menu 1 > SMOOTH**, and press  to edit the value.
- 3 Use the arrow keys to change the smooth refresh rate. Select **E** to enable the Smooth feature.
- 4 Press  to save your changes (or press  to discard your changes).
- 5 Press and hold  until the tester restarts to return to normal operation.

## Menu 2

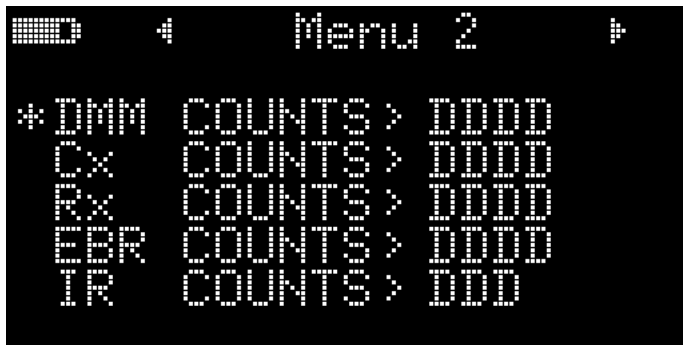

Menu Items	Learn more on:
DMM	
Cx	
Rx	<a href="#">"Changing the display count"</a> on page 114
EBR	
IR	

### Changing the display count

Use these settings to change the display count for the following measurements/tests.

Parameter	Affects	Range <sup>[1]</sup>		
		DDDDD	DDDD	DDD
DMM	Voltage, current <sup>[2]</sup> , and frequency measurements	66000/99999	<b>6600/9999</b>	-
Cx	Capacitance measurements	12000	<b>1200</b>	120
Rx	Resistance measurements	66000	<b>6600</b>	660
EBR	Earth-bond resistance measurements	-	<b>6600</b>	660
IR	Insulation resistance measurements	-	6600	<b>660</b>





[1] Default range is **bolded**.

[2] Model U1461A only.

#### NOTE

DAR and PI indications are fixed at 9999 counts.

To change the display count:

- 1 Press  for more than 1 second to enter the Setup menu.
- 2 Browse to **Menu 2**, select the desired measurement display count (**DMM**, **Cx**, **Rx**, **EBR**, or **IR**) and press  to edit the value.
- 3 Use the arrow keys to change the display count.
- 4 Press  to save your changes (or press  to discard your changes).
- 5 Press and hold  until the tester restarts to return to normal operation.

## Menu 3

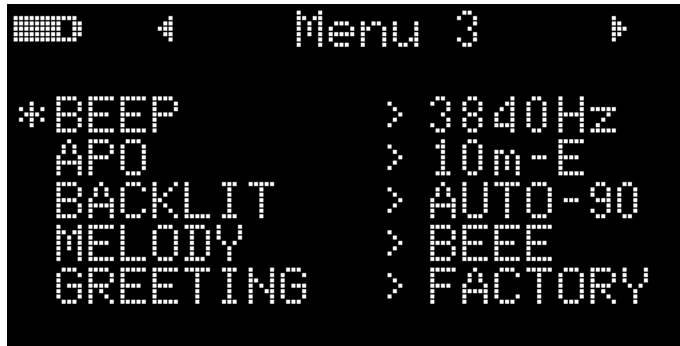



Menu Items	Learn more on:
BEEP	<a href="#">“Changing the beep frequency” on page 115</a>
APO	<a href="#">“Changing the auto power-off (APO) timer” on page 116</a>
BACKLIT	<a href="#">“Changing the OLED behavior” on page 116</a>
MELODY	<a href="#">“Disabling the power-on melody” on page 117</a>
GREETING	<a href="#">“Disabling the power-on greeting” on page 118</a>

### Changing the beep frequency

The beeper alerts users to the presence of circuit continuities and newly sensed values for Max Min recordings.



Parameter	Range	Default setting
BEEP	4267, 4151, 4042, 3938, 3840, 3746, 3675, 3572, 3491, 3413, 3339, 3268, 3200 (Hz), or OFF	3840 Hz

To change the beep frequency:

- 1 Press  for more than 1 second to enter the Setup menu.
- 2 Browse to **Menu 3 > BEEP**, and press  to edit the value.

## 4 Setup Options

### Setup Menu Items





- 3 Use the arrow keys to change the beep frequency. Select **OFF** to disable the beeper.
- 4 Press  to save your changes (or press  to discard your changes).
- 5 Press and hold  until the tester restarts to return to normal operation.

### Changing the auto power-off (APO) timer

The APO (see [page 6](#)) feature uses a timer to determine when to automatically turn the tester off.

Parameter	Range	Default setting
APO	<ul style="list-style-type: none"><li>• (1 to 99) minutes</li><li>• E(nabled) or D(isabled)</li></ul>	10 M-E

To change the APO timer period:





- 1 Press  for more than 1 second to enter the Setup menu.
- 2 Browse to **Menu 3 > APO**, and press  to edit the value.
- 3 Use the arrow keys to change the APO timer period. Select **D** to disable the APO feature.
- 4 Press  to save your changes (or press  to discard your changes).
- 5 Press and hold  until the tester restarts to return to normal operation.

### Changing the OLED behavior

The OLED is set to auto-dim by default. However, you can manually control the OLED brightness by changing the values in this Setup item.

Parameter	Range	Default setting
BACKLIT	LOW, MEDIUM, HIGH, or AUTO-NN	AUTO-90

To change the OLED behavior:



- 1 Press  for more than 1 second to enter the Setup menu.
- 2 Browse to **Menu 3 > BACKLIT**, and press  to edit the value.
- 3 Use the arrow keys to change the OLED behavior.
- 4 If you select **AUTO** (to enable the auto-dim feature), you can also use the arrow keys to change the auto-dim settling time. The display will auto-dim after (1 to 99 seconds) depending on the value selected.
- 5 Press  to save your changes (or press  to discard your changes).
- 6 Press and hold  until the tester restarts to return to normal operation.

### Disabling the power-on melody

The tester plays a melody or a beep when it is powered on.



Parameter	Range	Default setting
MELODY	FACTORY, USER, BEEE, or OFF	BEEE

To disable the power-on melody:

- 1 Press  for more than 1 second to enter the Setup menu.
- 2 Browse to **Menu 3 > MELODY**, and press  to edit the value.
- 3 Use the arrow keys to change the power-on melody. Select **OFF** to disable the power-on melody.

#### NOTE

The **USER** option is reserved for Agilent internal use.



- 4 Press  to save your changes (or press  to discard your changes).
- 5 Press and hold  until the tester restarts to return to normal operation.

### Disabling the power-on greeting

The tester displays the Agilent logo when it is powered on.



Parameter	Range	Default setting
GREETING	FACTORY, USER, or OFF	FACTORY

To disable the power on greeting:

- 1 Press  for more than 1 second to enter the Setup menu.
- 2 Browse to **Menu 3 > GREETING**, and press  to edit the value.
- 3 Use the arrow keys to change the power-on greeting. Select **OFF** to disable the power-on greeting.

#### NOTE

The **USER** option is reserved for Agilent internal use.

- 4 Press  to save your changes (or press  to discard your changes).
- 5 Press and hold  until the tester restarts to return to normal operation.



## Menu 4

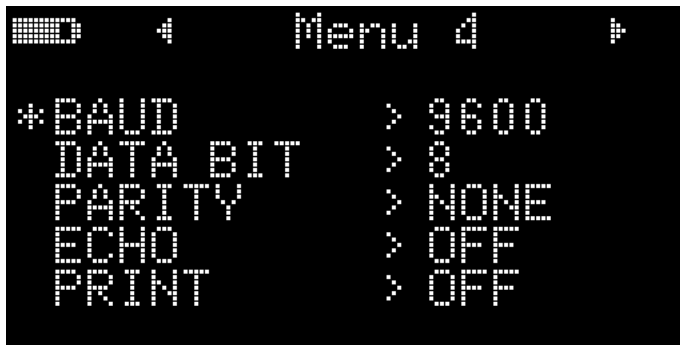



Menu Items	Learn more on:
BAUD	<a href="#">“Changing the baud rate”</a> on page 119
DATA BIT	<a href="#">“Changing the data bits”</a> on page 120
PARITY	<a href="#">“Changing the parity check”</a> on page 120
ECHO	<a href="#">“Enabling the echo feature”</a> on page 121
PRINT	<a href="#">“Enabling the print feature”</a> on page 121

### Changing the baud rate

This setting changes the baud rate for remote communications with a PC.



Parameter	Range	Default setting
BAUD	(9600 or 19200) bits/second	9600

To change the baud rate:

- 1 Press  for more than 1 second to enter the Setup menu.
- 2 Browse to **Menu 4 > BAUD**, and press  to edit the value.
- 3 Use the arrow keys to change the baud rate.

## 4 Setup Options

### Setup Menu Items





- 4 Press  to save your changes (or press  to discard your changes).
- 5 Press and hold  until the tester restarts to return to normal operation.

### Changing the data bits

This setting changes the number of data bits (data width) for remote communications with a PC. The number of stop bit is always 1, and this cannot be changed.

Parameter	Range	Default setting
DATA BIT	8-bit or 7-bit	8

To change the data bit:



- 1 Press  for more than 1 second to enter the Setup menu.
- 2 Browse to **Menu 4 > DATA BIT**, and press  to edit the value.
- 3 Use the arrow keys to change the data bit.
- 4 Press  to save your changes (or press  to discard your changes).
- 5 Press and hold  until the tester restarts to return to normal operation.



### Changing the parity check

This setting changes the parity check for remote communications with a PC.

Parameter	Range	Default setting
PARITY	NONE, EVEN, or ODD	NONE

To change the parity check:

- 1 Press  for more than 1 second to enter the Setup menu.
- 2 Browse to **Menu 4 > PARITY**, and press  to edit the value.





- 3 Use the arrow keys to change the parity check.
- 4 Press  to save your changes (or press  to discard your changes).
- 5 Press and hold  until the tester restarts to return to normal operation.

### Enabling the echo feature

When the echo feature is enabled, the tester echoes (returns) all the characters it receives when it is connected to a remote PC.

Parameter	Range	Default setting
ECHO	OFF or ON	OFF

To enable the echo feature:

- 1 Press  for more than 1 second to enter the Setup menu.
- 2 Browse to **Menu 4 > ECHO**, and press  to edit the value.
- 3 Use the arrow keys to enable the echo feature.
- 4 Press  to save your changes (or press  to discard your changes).
- 5 Press and hold  until the tester restarts to return to normal operation.

### Enabling the print feature





When the print feature is enabled, the tester will print out the measured data when the measuring cycle is complete. The tester will automatically send new data to the remote PC host continuously. The tester does not accept any commands from the PC host when this feature is enabled.

Parameter	Range	Default setting
PRINT	OFF or ON	OFF

## 4 Setup Options

### Setup Menu Items

To enable the print feature:

- 1 Press  for more than 1 second to enter the Setup menu.
- 2 Browse to **Menu 4 > PRINT**, and press  to edit the value.
- 3 Use the arrow keys to enable the print feature.
- 4 Press  to save your changes (or press  to discard your changes).
- 5 Press and hold  until the tester restarts to return to normal operation.

## Menu 5

```

  4  Menu 5
+REVISION > 01.00
S/N > 12731688
DUAL DC+AC > YES
ALERT HORN > BEE&LED
CONTINUITY > SHORT-E
  
```

Menu Items	Learn more on:
REVISION	-
S/N	-
DUAL DC+AC	<a href="#">“Enabling dual display for voltage and current measurements”</a> on page 123
ALERT HORN	<a href="#">“Changing the alert indicators”</a> on page 124
CONTINUITY	<a href="#">“Changing the continuity alert”</a> on page 124

### Enabling dual display for voltage and current measurements





This setting is used to enable dual display for voltage and current measurements. The AC+DC measurement will be shown on the secondary display.

Parameter	Range	Default setting
DUAL DC+AC	YES or NO	YES

## 4 Setup Options

### Setup Menu Items

To enable dual display:





- 1 Press  for more than 1 second to enter the Setup menu.
- 2 Browse to **Menu 5 > DUAL DC+AC**, and press  to edit the value. Select **NO** to disable the dual display.
- 3 Use the arrow keys to enable the dual display.
- 4 Press  to save your changes (or press  to discard your changes).
- 5 Press and hold  until the tester restarts to return to normal operation.

### Changing the alert indicators

The tester's audible and visual alerts users to the presence of circuit continuities (see [page 68](#)) and values exceeding the Limit values set (see [page 68](#)).

Parameter	Range	Default setting
ALERT HORN	BEE&LED, OFF&LED, BEE&OFF, OFF&OFF	BEE&LED

To change the alert indicators:





- 1 Press  for more than 1 second to enter the Setup menu.
- 2 Browse to **Menu 5 > ALERT HORN**, and press  to edit the value.
- 3 Use the arrow keys to change the alert indicators. Select **OFF** to disable either the beeper, the red LED, or both alert indicators.
- 4 Press  to save your changes (or press  to discard your changes).
- 5 Press and hold  until the tester restarts to return to normal operation.

### Changing the continuity alert

This setting is used with continuity tests (see [page 68](#)). The tester will beep to alert users to the presence of circuit continuities for short or open circuits.

Parameter	Range	Default setting
CONTINUITY	<ul style="list-style-type: none"> <li>• SHORT, OPEN, or TONE</li> <li>• D(isabled) or E(nabled)</li> </ul>	SHORT-E

To change the continuity alert:

- 1 Press  for more than 1 second to enter the Setup menu.
- 2 Browse to **Menu 5 > CONTINUITY**, and press  to edit the value.
- 3 Use the arrow keys to change the continuity alert. Select **D** to disable the continuity alert for either the **SHORT**, **OPEN**, or **TONE** alerts.
- 4 Press  to save your changes (or press  to discard your changes).
- 5 Press and hold  until the tester restarts to return to normal operation.

## Menu 6

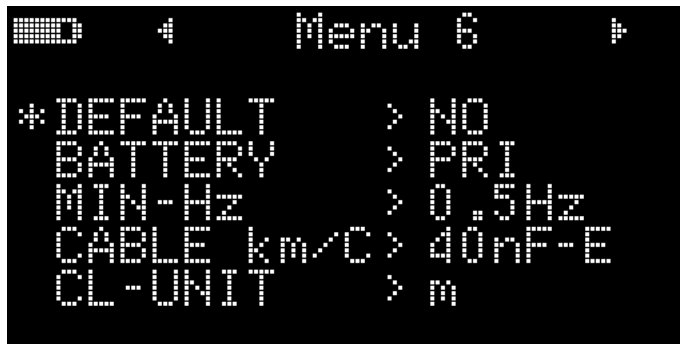

Menu Items	Learn more on:
DEFAULT	<a href="#">“Resetting the tester’s Setup options”</a> on page 126
BATTERY	<a href="#">“Changing the battery type”</a> on page 126

## 4 Setup Options





### Setup Menu Items

Menu Items	Learn more on:
MIN-Hz	<a href="#">“Changing the minimum measurable frequency”</a> on page 127
CABLE km/C	<a href="#">“Changing the cable length scale”</a> on page 127
CL-UNIT	<a href="#">“Changing the cable length unit”</a> on page 128

### Resetting the tester’s Setup options

The tester’s Setup options can be reset to its default values through the Setup menu.

Parameter	Range	Default setting
DEFAULT	YES or NO	NO



- 1 Press  for more than 1 second to enter the Setup menu.
- 2 Browse to **Menu 6 > DEFAULT**, and press  to edit the value.
- 3 Use the arrow keys to select **YES**.
- 4 Press and hold  for more than 1 second to perform the reset. The tester will beep once and return to the first Setup menu page. Or, alternatively press  to discard your changes.

### Changing the battery type

If you are using rechargeable batteries to power your tester, change the battery type from **PRI** to **SEC** for the tester to accurately reflect the battery capacity indication.

Parameter	Range	Default setting
BATTERY	PRI or SEC	PRI

To change the battery type:

- 1 Press  for more than 1 second to enter the Setup menu.
- 2 Browse to **Menu 6 > BATTERY**, and press  to edit the value.



- 3 Use the arrow keys to change the battery type.
- 4 Press **T DAR Pl** to save your changes (or press **Lock Hz Esc** to discard your changes).
- 5 Press and hold **⌘** until the tester restarts to return to normal operation.

### Changing the minimum measurable frequency

This setting is used with frequency tests (see [page 63](#)). Changing the minimum measurable frequency will influence the measurement rates for frequency, duty cycle, and pulse width measurements. The typical measurement rate as defined in the specification is based on a minimum measurable frequency of 10 Hz.

Parameter	Range	Default setting
MIN-Hz	0.5 Hz or 10 Hz	0.5 Hz

To change the minimum measurable frequency:

- 1 Press **⌘** for more than 1 second to enter the Setup menu.
- 2 Browse to **Menu 6 > MIN-Hz**, and press **T DAR Pl** to edit the value.
- 3 Use the arrow keys to change the minimum measurable frequency.
- 4 Press **T DAR Pl** to save your changes (or press **Lock Hz Esc** to discard your changes).
- 5 Press and hold **⌘** until the tester restarts to return to normal operation.

### Changing the cable length scale





This setting is used with capacitance measurements (see [page 75](#)). Change the unit (Meter or Feet) of the cable length display.

Parameter	Range	Default setting
CABLE km/C	<ul style="list-style-type: none"> <li>• (1 to 99) nF</li> <li>• D(isabled) or E(nabled)</li> </ul>	40 nF-E

## 4 Setup Options

### Setup Menu Items

To change the cable length scale:





- 1 Press  for more than 1 second to enter the Setup menu.
- 2 Browse to **Menu 6 > CABLE km/C** and press  to edit the value.
- 3 Use the arrow keys to change the cable length scale. Select **D** to disable the cable length display in capacitance measurements.
- 4 Press  to save your changes (or press  to discard your changes).
- 5 Press and hold  until the tester restarts to return to normal operation.

### Changing the cable length unit

This setting is used with capacitance measurements (see [page 75](#)). Change the scale from 1 nF to 99 nF per kilometer for capacitance transfers to cable length.

Parameter	Range	Default setting
CL-UNIT	m (Meter) or ft (Feet)	m (Meter)

To change the cable length unit:

- 1 Press  for more than 1 second to enter the Setup menu.
- 2 Browse to **Menu 6 > CL-UNIT** and press  to edit the value.
- 3 Use the arrow keys to change the cable length unit.
- 4 Press  to save your changes (or press  to discard your changes).
- 5 Press and hold  until the tester restarts to return to normal operation.

## Menu 7

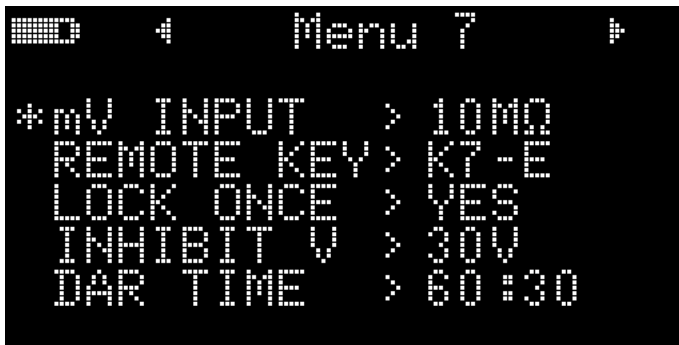





Menu Items	Learn more on:
mV INPUT	<a href="#">“Changing the input impedance for mV measurements” on page 129</a>
REMOTE KEY	<a href="#">“Changing the button operation on the remote switch probe” on page 130</a>
LOCK ONCE	<a href="#">“Disabling the lock once feature” on page 131</a>
INHIBIT V	<a href="#">“Changing the maximum inhibit voltage for insulation resistance tests” on page 131</a>
DAR TIME	<a href="#">“Changing the Dielectric Absorption Ratio (DAR) for insulation resistance tests” on page 132</a>

### Changing the input impedance for mV measurements

This setting is used with voltage measurements, up to millivolts (see [page 36](#)). Select an appropriate input impedance value according to your requirements.







Parameter	Range	Default setting
mV INPUT	10 MΩ or >1 GΩ	10 MΩ

To change the input impedance for mV measurements:





- 1 Press  for more than 1 second to enter the Setup menu.
- 2 Browse to **Menu 7 > mV INPUT**, and press  to edit the value.
- 3 Use the arrow keys to change the input impedance value.
- 4 Press  to save your changes (or press  to discard your changes).
- 5 Press and hold  until the tester restarts to return to normal operation.

### Changing the button operation on the remote switch probe

This setting is used with the remote switch probe. The button operation on the remote switch probe will emulate the function selected in this setting.

Parameter	Range	Default setting
REMOTE KEY	<ul style="list-style-type: none"> <li>• K1 - </li> <li>• K2 - </li> <li>• K3 - </li> <li>• K4 - </li> <li>• K5 - </li> <li>• K6 - </li> <li>• K7 - </li> <li>• D(isable) or E(nable)</li> </ul>	K7 - E

To change the button operation on the remote switch probe:

- 1 Press  for more than 1 second to enter the Setup menu.
- 2 Browse to **Menu 7 > REMOTE KEY**, and press  to edit the value.
- 3 Use the arrow keys to change the function of the remote switch probe button. Select **D** to disable the remote switch probe button.
- 4 Press  to save your changes (or press  to discard your changes).
- 5 Press and hold  until the tester restarts to return to normal operation.





### Disabling the lock once feature

This setting is used with insulation resistance tests (see [page 51](#)) and earth-bond resistance measurements (see [page 51](#)). By default, the tester will reset the locked status when the test is stopped by pressing .

If you disable this feature, you will need to press  to unlock the tester, even if the test has already stopped.

Parameter	Range	Default setting
LOCK ONCE	YES or NO	YES

To disable the lock once feature:



- 1 Press  for more than 1 second to enter the Setup menu.
- 2 Browse to **Menu 7 > LOCK ONCE**, and press  to edit the value.
- 3 Use the arrow keys to select **NO**.
- 4 Press  to save your changes (or press  to discard your changes).
- 5 Press and hold  until the tester restarts to return to normal operation.

### Changing the maximum inhibit voltage for insulation resistance tests

This setting is used with insulation resistance tests (see [page 51](#)). The tester will not perform the insulation resistance test if it detects that the external voltage exceeds the inhibit voltage value set here.



Parameter	Range	Default setting
INHIBIT V	30 V, 50 V, or 75 V	75 V

To change the maximum inhibit voltage:

- 1 Press  for more than 1 second to enter the Setup menu.
- 2 Browse to **Menu 7 > INHIBIT V**, and press  to edit the value.
- 3 Use the arrow keys to change the value of the inhibit voltage.

## 4 Setup Options

### Setup Menu Items





- 4 Press  to save your changes (or press  to discard your changes).
- 5 Press and hold  until the tester restarts to return to normal operation.

### Changing the Dielectric Absorption Ratio (DAR) for insulation resistance tests

This setting is used with insulation resistance tests (see [page 51](#)). The tester performs the DAR test using the ratio set here.

Parameter	Range	Default setting
DAR TIME	60:30 or 60:15 (seconds)	60:30 (seconds)

To change the DAR ratio:

- 1 Press  for more than 1 second to enter the Setup menu.
- 2 Browse to **Menu 7 > DAR TIME**, and press  to edit the value.
- 3 Use the arrow keys to change the value of the DAR ratio.
- 4 Press  to save your changes (or press  to discard your changes).
- 5 Press and hold  until the tester restarts to return to normal operation.

## Menu 8

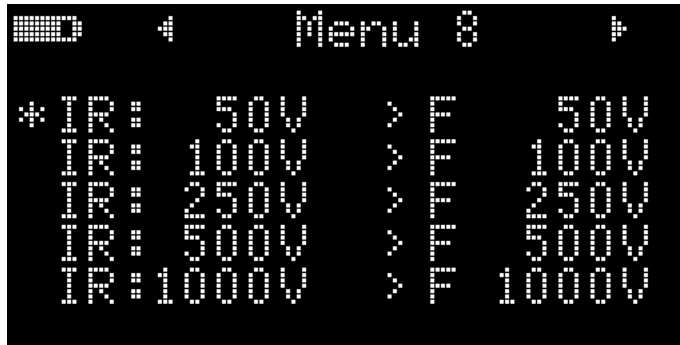

Menu Items	Learn more on:
IR: 50 V	
IR: 100 V	
IR: 250 V	<a href="#">“Changing the insulation resistance test voltage”</a> on page 133
IR: 500 V	
IR: 1000 V	

### Changing the insulation resistance test voltage

This setting is used with insulation resistance tests (see [page 51](#)). Select **U(ser)** to manually change the test voltage value for insulation resistance tests.

Parameter	Range	
	F(actory)	U(ser) <sup>[1]</sup>
IR: 50 V	50 V	10 V to 60 V
IR: 100 V	100 V	10 V to 120 V
IR: 250 V	250 V	10 V to 300 V





## 4 Setup Options

### Setup Menu Items

Parameter	Range	
	F(actory)	U(ser) <sup>[1]</sup>
IR: 500 V	500 V	10 V to 600 V
IR: 1000 V	1000 V	10 V to 1100 V

[1] Minimum increment of 1 V between each subsequent value.

To change the insulation resistance test voltage:

- 1 Press  for more than 1 second to enter the Setup menu.
- 2 Browse to **Menu 10**, select the desired insulation resistance test voltage (**IR: 50 V**, **IR: 100 V**, **IR: 250 V**, **IR: 500 V**, or **IR: 1000 V**) and press  to edit the value.
- 3 Select **U** and use the arrow keys to change the test voltage.
- 4 Press  to save your changes (or press  to discard your changes).
- 5 Press and hold  until the tester restarts to return to normal operation.

## Menu 9

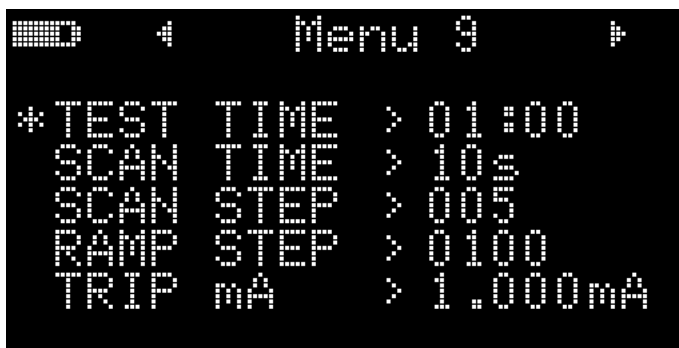







Menu Items	Learn more on:
TEST TIME	<a href="#">“Changing the insulation resistance and earth-bond resistance test period”</a> on page 135
SCAN TIME	<a href="#">“Changing the scan signal dwelling time”</a> on page 135
SCAN STEP	<a href="#">“Changing the scan signal number of steps”</a> on page 136
RAMP STEP	<a href="#">“Changing the ramp signal number of steps”</a> on page 137
TRIP mA	<a href="#">“Changing the trip current value”</a> on page 137

### Changing the insulation resistance and earth-bond resistance test period

This setting is used with insulation resistance tests (see [page 51](#)) or earth-bond resistance measurements (see [page 51](#)). The tester performs the test over the timed period defined in this setting.

Parameter	Range	Default setting
TEST TIME	00:05 to 59:59	01:00

To change the insulation resistance and earth-bond resistance test period:





- 1 Press  for more than 1 second to enter the Setup menu.
- 2 Browse to **Menu 9 > TEST TIME**, and press  to edit the value.
- 3 Use the arrow keys to change the test period.
- 4 Press  to save your changes (or press  to discard your changes).
- 5 Press and hold  until the tester restarts to return to normal operation.

### Changing the scan signal dwelling time

This setting is used with insulation resistance tests (see [page 51](#)). The scan signal will “dwell” in the present step for the length of time stated in the scan dwelling time before incrementing to the next step.

Parameter	Range	Default setting
SCAN TIME	(1 to 99) seconds	10 seconds

To change the scan signal dwelling time:





- 1 Press  for more than 1 second to enter the Setup menu.
- 2 Browse to **Menu 9 > SCAN TIME**, and press  to edit the value.
- 3 Use the arrow keys to change the dwelling time.
- 4 Press  to save your changes (or press  to discard your changes).
- 5 Press and hold  until the tester restarts to return to normal operation.

### Changing the scan signal number of steps

This setting is used with insulation resistance tests (see [page 51](#)). The increment of each step in the scan signal will be the amplitude end position divided by the number of steps. Each step should be set to greater than 10 V and the last step is equal to or less than the test voltage setting.

Parameter	Range	Default setting
SCAN STEP	(1 to 100) steps	5 steps

To change the scan signal number of steps:





- 1 Press  for more than 1 second to enter the Setup menu.
- 2 Browse to **Menu 9 > SCAN STEP**, and press  to edit the value.
- 3 Use the arrow keys to change the number of steps.
- 4 Press  to save your changes (or press  to discard your changes).
- 5 Press and hold  until the tester restarts to return to normal operation.

### Changing the ramp signal number of steps

This setting is used with insulation resistance tests (see [page 51](#)). The increment of each step in the ramp signal will be the amplitude end position divided by the number of steps. For example, a 50 V amplitude end position divided by 100 steps gives an increment of 0.5 V per step.

Parameter	Range	Default setting
RAMP STEP	(1 to 1000) steps	100 steps

To change the ramp signal number of steps:



- 1 Press  for more than 1 second to enter the Setup menu.
- 2 Browse to **Menu 9 > RAMP STEP**, and press  to edit the value.
- 3 Use the arrow keys to change the number of steps.
- 4 Press  to save your changes (or press  to discard your changes).
- 5 Press and hold  until the tester restarts to return to normal operation.

### Changing the trip current value

This setting is used with insulation resistance tests (see [page 51](#)). Set the current value for tripping the insulation resistance test (trip by leakage current/breakdown current).



Parameter	Range	Default setting
TRIP mA	(0.001 to 1.500) mA	1.000 mA

To change the trip current value:

- 1 Press  for more than 1 second to enter the Setup menu.
- 2 Browse to **Menu 9 > TRIP mA**, and press  to edit the value.
- 3 Use the arrow keys to change the trip current.

## 4 Setup Options

Setup Menu Items

- 4 Press  to save your changes (or press  to discard your changes).
- 5 Press and hold  until the tester restarts to return to normal operation.

### Menu 10

**NOTE**

Menu 10 is for model U1461A only.

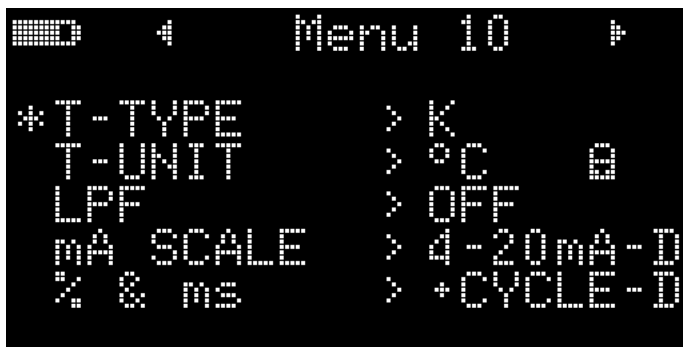





Menu Items	Learn more on:
T-TYPE	<a href="#">“Changing the thermocouple type” on page 139</a>
T-UNIT	<a href="#">“Changing the temperature unit” on page 139</a>
LPF	<a href="#">“Enabling the low-pass filter” on page 140</a>
mA SCALE	<a href="#">“Changing the % (mA) scale range” on page 141</a>
% & ms	<a href="#">“Enabling the (+ or -) duty cycle and pulse width display” on page 141</a>

## Changing the thermocouple type

This setting is used with temperature measurements (see [page 78](#)). Select a thermocouple type that matches the thermocouple sensor you are using for temperature measurements.

Parameter	Range	Default setting
T-TYPE	Type-J or Type-K	K

To change the thermocouple type:



- 1 Press  for more than 1 second to enter the Setup menu.
- 2 Browse to **Menu 10 > T-TYPE**, and press  to edit the value.
- 3 Use the arrow keys to change the thermocouple type.
- 4 Press  to save your changes (or press  to discard your changes).
- 5 Press and hold  until the tester restarts to return to normal operation.

## Changing the temperature unit

### CAUTION

This Setup item is locked for certain regions. Always set the temperature unit display per the official requirements and in compliance with the National laws of your region.







This setting is used with temperature measurements (see [page 78](#)). Four combinations of displayed temperature unit(s) are available:

- Celsius only: Temperature measured in °C.
- Fahrenheit/Celsius: During temperature measurements, press  to switch between °F and °C.
- Celsius/Fahrenheit: During temperature measurements, press  to switch between °C and °F.
- Fahrenheit only: Temperature measured in °F.

Press and hold  for more than 1 second to unlock this setting.

Parameter	Range	Default setting
T-UNIT	°C, °F/°C, °C/°F, or °F	°C

To change the temperature unit:





- 1 Press  for more than 1 second to enter the Setup menu.
- 2 Browse to **Menu 10 > T-UNIT**. Press and hold  for more than 1 second to unlock this setting, then press  to edit the value.
- 3 Use the arrow keys to change the temperature unit.
- 4 Press  to save your changes (or press  to discard your changes).
- 5 Press and hold  until the tester restarts to return to normal operation.

### Enabling the low-pass filter

This setting is used to enable the low-pass filter to filter out higher frequencies with (AC/DC path) V, mV,  $\mu$ A, or mA measurements. The  symbol is shown during these measurements.

Parameter	Range	Default setting
LPF	ON or OFF	OFF

To enable the filter:





- 1 Press  for more than 1 second to enter the Setup menu.
- 2 Browse to **Menu 10 > LPF**, and press  to edit the value.
- 3 Use the arrow keys to enable the filter.
- 4 Press  to save your changes (or press  to discard your changes).
- 5 Press and hold  until the tester restarts to return to normal operation.

### Changing the % (mA) scale range

This setting is used with % (mA) scale current measurements (see [page 62](#)). The tester converts DC current measurements to a percentage scale readout of 0% to 100% based on the selected range in this menu. For example, a 25% readout represents a DC current of 8 mA on the 4-20 mA % scale, or a DC current of 5 mA on the 0-20 mA % scale.

Parameter	Range	Default setting
mA SCALE	<ul style="list-style-type: none"> <li>4-20 mA or 0-20 mA</li> <li>D(isable) or E(nable)</li> </ul>	4-20 mA-D

To change the % (mA) scale range:



- 1 Press  for more than 1 second to enter the Setup menu.
- 2 Browse to **Menu 10 > mA SCALE**, and press  to edit the value.
- 3 Use the arrow keys to change the % scale range. Select **D** to disable the mA scale readout.
- 4 Press  to save your changes (or press  to discard your changes).
- 5 Press and hold  until the tester restarts to return to normal operation.

### Enabling the (+ or –) duty cycle and pulse width display

This setting is used with frequency measurements (see [page 63](#)). Enabling this feature will allow you to display (+ or –) duty cycle and pulse width along with frequency for voltage or current measurements.



Parameter	Range	Default setting
% & ms	<ul style="list-style-type: none"> <li>+CYCLE or –CYCLE</li> <li>D(isable) or E(nable)</li> </ul>	+CYCLE-D

To enable the duty cycle and pulse width display:

- 1 Press  for more than 1 second to enter the Setup menu.
- 2 Browse to **Menu 10 > % & ms**, and press  to edit the value.

## 4 Setup Options

### Setup Menu Items

- 3 Use the arrow keys to change the duty cycle and pulse width settings. Select **E** to enable the duty cycle and pulse width display.
- 4 Press  to save your changes (or press  to discard your changes).
- 5 Press and hold  until the tester restarts to return to normal operation.





## 5 Characteristics and Specifications

Product Characteristics	144
Specification Considerations	146
Measurement Category	146
Electrical Specifications	147
DC specifications	147
AC specifications	150
Capacitance specifications	152
Temperature specifications	153
Frequency specifications	154
Duty cycle and pulse width specifications (model U1461A only)	155
Frequency sensitivity specifications	157
Insulation resistance specifications	159
Earth-bond resistance specifications	161
Adjustable DC test voltage specifications	161
EN61557 specifications	162
Display update rate (approximate)	163

This chapter lists the characteristics, considerations, and specifications of the U1461A/U1453A tester.



# Product Characteristics

---

### POWER SUPPLY

Battery type:

- 4 × 1.5 V AA Alkaline batteries (ANSI/NEDA 15A or IEC LR6)
- 4 × 1.5 V AA Lithium Iron Disulfide batteries (ANSI/NEDA 15LF or IEC FR6)
- 4 × 1.5 V AA Zinc Chloride batteries (ANSI/NEDA 15D or IEC R6)

Battery life:

- Based on new alkaline batteries for DC voltage measurement at room temperature:
  - 50 hours typical at high brightness
  - 60 hours typical at medium brightness
  - 80 hours typical at low brightness
- Note that the lithium batteries provided with the shipment typically last two times longer than the battery life or the test times stated for alkaline batteries.
- Insulation Resistance (IR) test: 1000 times of standard test with new alkaline batteries at room temperature. The standard test is 1000 V into 1 M $\Omega$  with a cycling of 5 seconds ON and 25 or 55 seconds OFF at low brightness.
- Earth-Bond Resistance (EBR) test: 2500 or 2100 times of standard test with new alkaline batteries at room temperature. The standard test is 1  $\Omega$  with a cycling of 5 seconds ON and 25 or 55 seconds OFF at low brightness.
- Low battery indicator will flash when the battery voltage drops below
  - For normal operation: 4.1 V (approximately)
  - For IR and EBR operation: 4.7 V (approximately)

---

### POWER CONSUMPTION

2.7 VA maximum (with maximum brightness)

---

### FUSE

10 × 35 mm 30 kA fast-acting fuse

---

### DISPLAY

- Organic LED (OLED) with maximum reading of 6600/66000 and 660/6600 counts selectable

---

### OPERATING ENVIRONMENT

Refer to “[Environmental Conditions](#)” on page VI

---

### STORAGE COMPLIANCE

Refer to “[Environmental Conditions](#)” on page VI

---

### SAFETY AND EMC COMPLIANCE

Refer to “[Environmental Conditions](#)” on page VI

---

---

**SURGE PROTECTION**

8 kV peak per IEC1010.1-92 (IEC1010-1)

---

**MEASUREMENT CATEGORY**

CAT III 1000 V/CAT IV 600 V

---

**IP RATING**

IP-67, protected against dust and the effect of immersion between 15 cm and 1 m

---

**DROP TEST**

1 meter per EN/IEC 61010-1:2001 and 3 meters, 6 sides drop to oak floor with holster.

---

**TEMPERATURE COEFFICIENT**

0.05 × (specified accuracy) / °C (from -40 °C to 18 °C, or 28 °C to 55 °C)

---

**COMMON MODE REJECTION RATIO (CMRR)**

>120 dB at DC, 50/60 Hz ± 0.1% (1 kΩ unbalanced)

---

**NORMAL MODE REJECTION RATIO (NMRR)**

>60 dB at 50/60 Hz ± 0.1%

---

**DIMENSIONS (W × H × D)**

100 × 218 × 58 mm

---

**WEIGHT**

686 grams (with lithium batteries and orange rubber holster)

---

**WARRANTY**

Please refer to [http://www.agilent.com/go/warranty\\_terms](http://www.agilent.com/go/warranty_terms)

- Three years for the product
  - Three months for the product's standard accessories, unless otherwise specified
  - Please take note that for the product, the warranty does not cover:
    - Damage from contamination
    - Normal wear and tear of mechanical components
    - Manuals, fuses, and standard disposable batteries
- 

**CALIBRATION CYCLE**

One year

---

## Specification Considerations

- Accuracy is given as  $\pm$  (% of reading + counts of least significant digit) at  $23\text{ }^{\circ}\text{C} \pm 5\text{ }^{\circ}\text{C}$ , with relative humidity less than 80% RH, and resolution counts are 6000. For high resolution, the accuracy will be 10 times of the offset.
- AC V and AC mA specifications are AC coupled, are true RMS, and are valid from 5% of range to 100% of range.
- The crest factor may be up to 3.0 at full-scale except for the 1000 V range where it is 1.5 at full scale.
- For non-sinusoidal waveforms, add (2% reading + 2% full scale) typical, for crest factors up to 3.

### WARNING

Exceeding the crest factor limit may result in an incorrect or a lower reading. Do not exceed the crest factor limit to avoid instrument damage and the risk of electric shock.

---

## Measurement Category

The Agilent U1461A/U1453A tester has a safety rating of CAT III, 1000 V and CAT IV, 600 V.

**Measurement CAT I** are for measurements performed on circuits not directly connected to the AC mains. Examples are measurements on circuits not derived from the AC mains and specially protected (internal) mains-derived circuits.

**Measurement CAT II** are measurements performed on circuits directly connected to a low-voltage installation. Examples are measurements on household appliances, portable tools, and similar equipment.

**Measurement CAT III** are measurements performed in the building installation. Examples are measurements on distribution boards, circuit-breakers, wiring, including cables, bus-bars, junction boxes, switches, socket outlets in the fixed installation, and equipment for industrial use, and some other equipment including stationary motors with permanent connection to the fixed installation.

**Measurement CAT IV** are measurements performed at the source of the low-voltage installation. Examples are electricity meters and measurements on primary overcurrent protection devices and ripple control units.

## Electrical Specifications

**NOTE**

Specification considerations are given on [page 146](#).

### DC specifications

**Table 5-1** DC voltage specifications with accuracy of  $\pm$  (% of reading + no. of least significant digit)

Function	Range	Resolution	Accuracy	Input impedance
Voltage	60 mV <sup>[1]</sup>	0.01 mV	0.09% + 1	10 M $\Omega$ <sup>[3]</sup>
	600 mV <sup>[1]</sup>	0.1 mV	0.09% + 1	10 M $\Omega$ <sup>[3]</sup>
	6 V <sup>[2]</sup>	0.001 V	0.09% + 1	11.11 M $\Omega$
	60 V <sup>[2]</sup>	0.01 V	0.09% + 1	10.1 M $\Omega$
	600 V <sup>[2]</sup>	0.1 V	0.09% + 1	10 M $\Omega$
	1000 V <sup>[2]</sup>	1 V	0.09% + 1	10 M $\Omega$

**Notes:**

- 1 The following statements are true for DC mV measurements:
  - DC mV measurements are for model U1461A only.
  - The accuracy is specified after the Null function is used to subtract the thermal effect (by shorting the test leads).
  - DC mV overload protection: 1000 V<sub>RMS</sub> for short circuits with <0.3 A current.
- 2 DC V overload protection: 1000 V<sub>RMS</sub>.
- 3 The input impedance may be set to >1 G $\Omega$  in the Setup menu.

## 5 Characteristics and Specifications

### Electrical Specifications

**Table 5-2** Resistance/Audible continuity specifications with accuracy of  $\pm$  (% of reading + no. of least significant digit)

Function	Range	Resolution	Accuracy	Continuity Threshold
Resistance <sup>[1]</sup>	600 $\Omega$ <sup>[2]</sup>	0.1 $\Omega$	0.5% + 2	12 $\pm$ 4 $\Omega$
	6 k $\Omega$	0.001 k $\Omega$	0.5% + 2	0.06 $\pm$ 0.02 k $\Omega$
	60 k $\Omega$	0.01 k $\Omega$	0.5% + 2	0.33 $\pm$ 0.17 k $\Omega$
	600 k $\Omega$	0.1 k $\Omega$	0.5% + 2	3.6 $\pm$ 1.8 k $\Omega$
	6 M $\Omega$ <sup>[3]</sup>	0.001 M $\Omega$	0.8% + 2	0.13 $\pm$ 0.07 M $\Omega$
	60 M $\Omega$ <sup>[3][4]</sup>	0.01 M $\Omega$	1.5% + 3	0.13 $\pm$ 0.07 M $\Omega$

**Notes:**

- The following statements are true for resistance measurements:
  - Overload protection: 1000 V<sub>RMS</sub> for short circuits with <0.3 A current.
  - Maximum open voltage is <+2.1 V.
  - The built-in buzzer beeps when the resistance measured is less than 12  $\Omega \pm 4 \Omega$ . The tester can capture intermittent measurements longer than 1 ms.
- The accuracy of the 600 M $\Omega$  range is specified after the Null function is used to subtract the test lead resistance and thermal effect (by shorting the test leads).
- For the ranges of 6 M $\Omega$  and 60 M $\Omega$ , the RH is specified for <60% @ 30 °C.
- The temperature coefficient of the 60 M $\Omega$  range is 0.1  $\times$  (specified accuracy)/°C (from -40 °C to 18 °C or 28 °C to 55 °C).

**Table 5-3** Diode specifications with accuracy of  $\pm$  (% of reading + no. of least significant digit)

Function	Range	Resolution	Accuracy	Test current
Diode <sup>[1]</sup>	1 V <sup>[2]</sup>	0.001 V	2% + 3	0.21 mA
	Auto <sup>[3]</sup>	0.001 V	2% + 3	0.21 mA

**Notes:**

- The following statements are true for diode tests:
  - Overload protection: 1000 V<sub>RMS</sub> for short circuits with <0.3 A current.
  - The built-in buzzer beeps continuously when the voltage measured is less than 0.04  $\pm$  0.02 V and beeps once for forward-biased diode or semiconductor junctions measured between 0.3 V and 0.8 V (0.3 V  $\leq$  reading  $\leq$  0.8 V).
- Open voltage for diode: <+2.1 V<sub>DC</sub>.
- Open voltage for Auto-diode: <+2.1 V<sub>DC</sub> and >-2.1 V<sub>DC</sub>.
- The maximum indication of threshold voltage is less than 1 V.

**Table 5-4** DC current specifications with accuracy of  $\pm$  (% of reading + no. of least significant digit) (model U1461A only)

Function	Range	Resolution	Accuracy	Burden voltage / Shunt
Current <sup>[1]</sup>	6 $\mu$ A	0.001 $\mu$ A	0.8% + 2 <sup>[3]</sup>	<0.24 V/39.2 k $\Omega$
	60 $\mu$ A	0.01 $\mu$ A	0.4% + 1 <sup>[3]</sup>	<0.24 V/3.56 k $\Omega$
	600 $\mu$ A	0.1 $\mu$ A	0.2% + 1	<0.062 V/100 $\Omega$
	6 mA	0.001 mA	0.2% + 1	<0.62 V/100 $\Omega$
	60 mA	0.01 mA	0.2% + 1	<0.16 V/1 $\Omega$
	440 mA <sup>[2]</sup>	0.1 mA	0.2% + 1	<1.17 V/1 $\Omega$

**Notes:**

- 1 Overload protection: 0.44 A/1000 V; 10  $\times$  35 mm 30 kA fast-acting fuse.
- 2 Specification for 440 mA range: 440 mA continuous for signals >440 mA up to 600 mA for 120 seconds maximum.
- 3 The accuracy of the 6  $\mu$ A to 60  $\mu$ A range is specified after the Null function is used to zero the offset (by opening the test leads).

## 5 Characteristics and Specifications

### Electrical Specifications

## AC specifications

**Table 5-5** True RMS AC voltage specifications with accuracy of  $\pm$  (% of reading + no. of least significant digit)

Function	Range	Resolution	Accuracy		
			45 Hz to 65 Hz	65 Hz to 5 kHz	5 kHz to 20 kHz
Voltage <sup>[6]</sup>	60 mV <sup>[1][2][4]</sup>	0.01 mV	1.0% + 3	1.5% + 3	2.0% + 4
	600 mV <sup>[1][2][4]</sup>	0.1 mV	1.0% + 3	1.5% + 3	2.0% + 4
	6 V <sup>[3][5]</sup>	0.001 V	1.0% + 3	1.5% + 3	2.0% + 4
	60 V <sup>[3][5]</sup>	0.01 V	1.0% + 3	1.5% + 3	2.0% + 4
	600 V <sup>[3][5]</sup>	0.1 V	1.0% + 3	1.5% + 3 @ <1 kHz	-
	1000 V <sup>[3][5]</sup>	0.1 V	1.0% + 3	1.5% + 3 @ <1 kHz	-
	LPF (low-pass filter) enabled, applicable for all voltage ranges and resolution <sup>[1][3][5]</sup>			1.0% + 3	1.5% + 3 @ <200 Hz 6.0% + 3 @ <440 Hz

**Notes:**

- 1 AC mV and LPF measurements are for model U1461A only.
- 2 AC mV overload protection: 1000 VRMS for short circuits with <0.3 A current.
- 3 AC V overload protection: 1000 VRMS.
- 4 AC mV input impedance: The input impedance may be set to >1 G $\Omega$  in the Setup menu, the default input impedance is 10 M $\Omega$  in parallel with 100 pF (nominal).
- 5 AC V input impedance: 10 M $\Omega$  in parallel with <100 pF (nominal).
- 6 The input signal is lower than the product of 20,000,000 V $\times$ Hz.



**Table 5-6** True RMS AC current specifications with accuracy of  $\pm$  (% of reading + no. of least significant digit) (model U1461A only)

Function	Range	Resolution	Accuracy	Burden voltage / Shunt
			45 Hz to 1 kHz	
Current <sup>[1]</sup>	6 $\mu$ A	0.001 $\mu$ A	2.0% + 2	<0.24 V/39.2 k $\Omega$
	60 $\mu$ A	0.01 $\mu$ A	1.5% + 2	<0.24 V/3.56 k $\Omega$
	600 $\mu$ A	0.1 $\mu$ A	1.0% + 2	<0.062 V/100 $\Omega$
	6 mA	0.001 mA	1.0% + 2	<0.62 V/100 $\Omega$
	60 mA	0.01 mA	1.0% + 2	<0.16 V/1 $\Omega$
	440 mA <sup>[2]</sup>	0.1 A	1.0% + 2	<1.17 V/1 $\Omega$

**Notes:**

- 1 Overload protection: 0.44 A/1000 V; 10  $\times$  35 mm 30 kA fast-acting fuse.
- 2 Specification for 440 mA range: 440 mA continuous for signals >440 mA up to 600 mA for 120 seconds maximum.

## 5 Characteristics and Specifications

### Electrical Specifications

## Capacitance specifications

**Table 5-7** Capacitance specifications with accuracy of  $\pm$  (% of reading + no. of least significant digit)<sup>[1][2]</sup>

Range	Resolution	Accuracy	Measuring rate (at full scale)
10 nF	0.01 nF	1% + 2	5 times/second
100 nF	0.1 nF	1% + 2	
1 $\mu$ F	0.001 $\mu$ F	1% + 2	2.4 times/second
10 $\mu$ F	0.01 $\mu$ F	1% + 2	
100 $\mu$ F	0.1 $\mu$ F	1% + 2	
1 mF	0.001 mF	1% + 2	1.0 times/second
10 mF	0.01 mF	1% + 2	0.1 times/second

**Notes:**

- 1 Overload protection: 1000 VRMS for short circuits with <0.3 A current
- 2 The accuracy of for all ranges is specified based on a film capacitor or better, and after the Null function is used to subtract the residual values (by opening the test leads).

## Temperature specifications

**Table 5-8** Temperature specifications with accuracy of  $\pm$  (% of reading + offset error)<sup>[1]</sup>

Thermal type	Range	Resolution	Accuracy
K	-200 °C to 1372 °C	0.1 °C	1% + 1 °C
	-328 °F to 2502 °F	0.1 °F	1% + 1.8 °F
J	-200 °C to 1200 °C	0.1 °C	1% + 1 °C
	-346 °F to 2192 °F	0.1 °F	1% + 1.8 °F

**Notes:**

- 1 The following statements are true for temperature measurements:
  - The specifications above are specified after 60 minutes of warm-up time.
  - The accuracy does not include the tolerance of the thermocouple probe.
  - Do not allow the temperature sensor to contact a surface that is energized above 30 VRMS or 60 Vdc. Such voltages pose a shock hazard.
  - Ensure that the ambient temperature is stable within  $\pm 1$  °C and that the Null function is used to reduce the test lead's thermal effect and temperature offset. Before using Null function, set the tester to measure temperature without ambient compensation (  ) and keep the thermocouple probe as close to the tester as possible (avoid contact with any surface that has a different temperature from the ambient temperature).
  - When measuring temperature with respect to any temperature calibrator, try to set both the calibrator and tester with an external reference (without internal ambient compensation). If both the calibrator and tester are set with internal reference (with internal ambient compensation), some deviations may show between the readings of the calibrator and tester, due to differences in ambient compensation between the calibrator and tester. Keeping the tester close to the output terminal of calibrator will help reduce the deviation.
  - The temperature calculation is specified according to the safety standards of EN/IEC-60548-1 and NIST175.

## 5 Characteristics and Specifications

### Electrical Specifications

## Frequency specifications

**Table 5-9** Frequency specifications with accuracy of  $\pm$  (% of reading + no. of least significant digit)<sup>[1][2]</sup>

Range	Resolution	Accuracy	Minimum input frequency
99.99 Hz	0.01 Hz	0.02% + 1	0.5 Hz
999.9 Hz	0.1 Hz	0.02% + 1	
9.999 kHz	0.001 kHz	0.02% + 1	
99.99 kHz	0.01 kHz	0.02% + 1	
999.9 kHz	0.1 kHz	0.02% + 1 @ $\leq 100$ kHz	
9.999 MHz	0.001 MHz	0.02% + 1 @ $\leq 100$ kHz	

**Notes:**

- 1 Overload protection: 1000 V; input signal is  $<20,000,000 \text{ V} \times \text{Hz}$  (product of voltage and frequency).
- 2 The frequency measurement is susceptible to error when measuring low-voltage and low-frequency signals. Shielding inputs from external noise pickup is critical for minimizing measurement errors. Turning on the low-pass filter (model U1461A only) may help you to filter out the noise and achieve a stable reading.

## Duty cycle and pulse width specifications (model U1461A only)

**Table 5-10** Duty cycle and pulse width specifications with accuracy of  $\pm$  (% of reading + no. of least significant digit) <sup>[2]</sup>

Function	Mode	Range	Resolution	Accuracy at full scale
Duty cycle <sup>[2]</sup>	DC coupling	99.9%	-	0.3% per kHz + 0.3%
	AC coupling	99.9%	-	0.3% per kHz + 0.3%
Pulse width <sup>[3]</sup>	-	999.9 ms	0.01 ms	(duty cycle accuracy/frequency) + 0.01 ms
	-	2000 ms	0.1 ms	(duty cycle accuracy/frequency) + 0.1 ms

**Notes for duty cycle and pulse width specifications:**

- 1 Overload protection: 1000 V; input signal is  $<20,000,000 \text{ V} \times \text{Hz}$  (product of voltage and frequency).
- 2 The frequency measurement is susceptible to error when measuring low-voltage and low-frequency signals. Shielding inputs from external noise pickup is critical for minimizing measurement errors. Turning on the low-pass filter (model U1461A only) may help you to filter out the noise and achieve a stable reading.
- 3 The accuracy for duty cycle and pulse width measurements is based on a 6 V square-wave input to the DC 6 V range. For AC couplings, the duty cycle range can be measured within the range of 10% to 90% for signal frequencies  $>20 \text{ Hz}$ .
- 4 The range of the duty cycle is determined by the frequency of the signal:  
 $\{10 \mu\text{s} \times \text{frequency} \times 100\% \}$  to  $\{[1 - (10 \mu\text{s} \times \text{frequency})] \times 100\% \}$
- 5 The pulse width (positive or negative) must be  $>10 \mu\text{s}$ . The range of the pulse width is determined by the frequency of the signal.

## 5 Characteristics and Specifications

### Electrical Specifications

#### Duty cycle and pulse width calculation example

**Table 5-11** Duty cycle and pulse width calculation example

Frequency	Duty cycle range <sup>[1]</sup>		Accuracy	
	From	To	Duty cycle <sup>[2]</sup>	Pulse width <sup>[3]</sup>
100 Hz	0.1%	99.9%	0.33%	0.043 ms
1 kHz	1%	99%	0.6%	0.016 ms

**Notes for duty cycle and pulse width calculation example:**

- 1 The range of the duty cycle is determined from this equation:  
 $\{10 \mu\text{s} \times \text{frequency} \times 100\%$  to  $\{[1 - (10 \mu\text{s} \times \text{frequency})] \times 100\%$
- 2 The accuracy of the duty cycle is determined from this equation:  $[0.3\% \times (\text{frequency kHz})] + 0.3\%$
- 3 The accuracy of the pulse width is determined from this equation:  $(\text{duty cycle accuracy}/\text{frequency}) + 0.01 \text{ ms}$

## Frequency sensitivity specifications

### For voltage measurements

**Table 5-12** Frequency sensitivity and trigger level specifications for voltage measurements

Input range <sup>[1]</sup>	Minimum sensitivity (RMS sine wave)	Trigger level for DC coupling
	20 Hz to 100 kHz	20 Hz to 100 kHz
60 mV	10 mV	15 mV
600 mV	27 mV	55 mV
6 V	0.25 V	0.55 V
60 V	2.5 V	5.5 V
600 V	25 V	55 V
1000 V	170 V	460 V

**Notes:**

**1** Maximum input for specified accuracy, refer to “AC specifications” on page 150.

## 5 Characteristics and Specifications

### Electrical Specifications

#### For current measurements (model U1461A only)

**Table 5-13** Frequency sensitivity specifications for current measurements

Input range <sup>[1]</sup>	Minimum sensitivity (RMS sine wave)
	20 Hz to 20 kHz
6 $\mu$ A	0.5 $\mu$ A
60 $\mu$ A	5 $\mu$ A
600 $\mu$ A	45 $\mu$ A
6 mA	0.45 mA
60 mA	4.5 mA
440 mA	45 mA

**Notes:**

**1** Maximum input for specified accuracy, refer to “AC specifications” on page 150.



## Insulation resistance specifications

**Table 5-14** Insulation resistance specifications with accuracy of  $\pm$  (% of reading + no. of least significant digit)

Test voltage	Range	Resolution	Accuracy	Test current
50 V	6 M $\Omega$	0.001 M $\Omega$	1.5% + 5	1 mA @ 50 k $\Omega$
	<50 M $\Omega$	0.01 M $\Omega$	1.5% + 5	
	~60 G $\Omega$	~0.01 G $\Omega$	1.5% + 5 <sup>[7]</sup>	
100 V	6 M $\Omega$	0.001 M $\Omega$	1.5% + 5	1 mA @ 100 k $\Omega$
	60 M $\Omega$	0.01 M $\Omega$	1.5% + 5	
	<100 M $\Omega$	0.1 M $\Omega$	1.5% + 5	
	~60 G $\Omega$	~0.01 G $\Omega$	1.5% + 5 <sup>[7]</sup>	
250 V	6 M $\Omega$	0.001 M $\Omega$	1.5% + 5	1 mA @ 250 k $\Omega$
	60 M $\Omega$	0.01 M $\Omega$	1.5% + 5	
	<250 M $\Omega$	0.1 M $\Omega$	1.5% + 5	
	~200 G $\Omega$	~0.1 G $\Omega$	1.5% + 5 <sup>[7]</sup>	
500 V	6 M $\Omega$	0.001 M $\Omega$	1.2% + 5	1 mA @ 500 k $\Omega$
	60 M $\Omega$	0.01 M $\Omega$	1.2% + 5	
	<500 M $\Omega$	0.1 M $\Omega$	1.2% + 5	
	~200 G $\Omega$	~0.1 G $\Omega$	1.2% + 5 <sup>[7]</sup>	
1000 V	6 M $\Omega$	0.001 M $\Omega$	1.2% + 5	1 mA @ 1 M $\Omega$
	60 M $\Omega$	0.01 M $\Omega$	1.2% + 5	
	600 M $\Omega$	0.1 M $\Omega$	1.2% + 5	
	<1 G $\Omega$	0.001 G $\Omega$	1.2% + 5	
	~200 G $\Omega$	~0.1 G $\Omega$	1.2% + 5 <sup>[7]</sup>	

## 5 Characteristics and Specifications

### Electrical Specifications

#### Notes:

- 1 The voltage indication on the display refers to the voltage at the DUT (device under test), and the accuracy is according to the DC voltage measurement. The marked test voltage and the actual test voltage may be different if the test voltage is adjusted in the Setup. Refer to the table below for more details:

$\Omega$ Mega position (Mark)	1000 V	500 V	250 V	100 V	50 V
Default test voltage (Factory)	1000 V	500 V	250 V	100 V	50 V
Deviation	2.0 V	1.5 V	1.5 V	1.5 V	1.0 V
	0.2%	0.3%	0.6%	1.5%	2.0%
Adjustable test voltage (User)	10 to 1100 V	10 to 600 V	10 to 300 V	10 to 120 V	10 to 60 V
Incremental	1 V	1 V	1 V	1 V	1 V

- 2 Live circuit detection: The test will be inhibited if the terminal voltage >30 V/50 V/75 V (AC/DC) prior to initialization of the test.
- 3 Short-circuit test current: 1.0 mA nominal.
- 4 Auto discharge time: <0.5 seconds for capacitors less or equal to 1  $\mu$ F.
- 5 Maximum capacitive load: Operable with up to 1  $\mu$ F load.
- 6 The accuracy of the leakage current may be referred to as the DC current measurement.
- 7 Additional accuracy is to be added to the basic accuracy as shown in the table below.

Voltage	1000 V	500 V	250 V	100 V	50 V
Above	1 G $\Omega$	500 M $\Omega$	250 M $\Omega$	100 M $\Omega$	50 M $\Omega$
Basic accuracy	1.2% + 5	1.2% + 5	1.5% + 5	1.5% + 5	1.5% + 5
Additional accuracy	0.05%/G $\Omega$	0.1%/G $\Omega$	0.2%/G $\Omega$	0.5%/G $\Omega$	1.0%/G $\Omega$

## Earth-bond resistance specifications

**Table 5-15** Earth-bond resistance specifications with accuracy of  $\pm$  (% of reading + no. of least significant digit)<sup>[1]</sup>

Range	Resolution	Accuracy	Open circuit voltage
6 $\Omega$ <sup>[2]</sup>	0.001 $\Omega$	0.5% + 20	>4 V and <7V
60 $\Omega$ <sup>[2]</sup>	0.01 $\Omega$	0.5% + 2	
600 $\Omega$ <sup>[2]</sup>	0.1 $\Omega$	0.5% + 2	
6 k $\Omega$	0.001 k $\Omega$	0.5% + 2	
60 k $\Omega$	0.01 k $\Omega$	0.5% + 2	

**Notes:**

- The following statements are true for earth-bond resistance tests:
  - Overload protection: 0.44 A/1000 V; 10  $\times$  35 mm 30 kA fast-acting fuse
  - Short circuit current: >200.0 mA as resistance < or = 2  $\Omega$
- The accuracy of the 6  $\Omega$  to 600  $\Omega$  range is specified after the Null function is used to subtract the test lead resistance and thermal effect (by shorting the test leads).

## Adjustable DC test voltage specifications

**Table 5-16** Adjustable DC test voltage specifications with accuracy of  $\pm$  (% of reading + no. of least significant digit)<sup>[1][2]</sup>

Range	Resolution	Accuracy	Rate current
1100 V	1 V	0.5% + 1	1 mA nominal

**Notes:**

- The minimum test voltage may be set from 10 V.
- The indication at the rated output voltage across a resistor with a value of  $UN \times (1000 \Omega/V)$  shall not differ by more than 10% relative to the indicated value, as a result of possibly present AC voltage components in the output voltage, when a capacitor of 1  $\mu$ F is connected in parallel with the insulation resistance to be measured.

## 5 Characteristics and Specifications

### Electrical Specifications

## EN61557 specifications

The following specifications are a requirement for European labeling.

Measurement	Intrinsic uncertainty		Operating uncertainty <sup>[1]</sup>
	U1461A	U1453A	
Voltage	$\pm (0.09\% + 1)$	$\pm (0.09\% + 1)$	30%
Earth-bond resistance	$\pm (0.5\% + 2)$	$\pm (0.5\% + 2)$	30%
	$\pm (0.5\% + 20)^{[2]}$	$\pm (0.5\% + 20)^{[2]}$	30%
Insulation resistance	Based on the test voltage and range. See “ <a href="#">Insulation resistance specifications</a> ” on page 159.		30%

#### Notes:

- 1 The maximum resistance to meet the standard of EN61557-1, 5.2.4, which indicates the maximum amount allowed as less than 30%.
- 2 For 6  $\Omega$  range only.

Test voltage <sup>[1][2]</sup>	IR <	Intrinsic uncertainty (A)	Temperature (E3)	Operating Uncertainty
50 V	25.7 G $\Omega$	27.65%	2%	$27.65\% + 1.15 \times E3$
100 V	51.4 G $\Omega$	27.65%	2%	$27.65\% + 1.15 \times E3$
250 V	131 G $\Omega$	25.65%	2%	$25.65\% + 1.15 \times E3$
500 V	260 G $\Omega$	27.45%	2%	$27.45\% + 1.15 \times E3$
1000 V	260 G $\Omega$	14.45%	2%	$14.45\% + 1.15 \times E3$

#### Notes:

- 1 Specification confidence level to 99.73% as coverage factor up to 3.
- 2 Temperature range is from 0 °C to 35 °C.

## Display update rate (approximate)

**Table 5-17** Display update rate (approximate)<sup>[1]</sup> [2]

Function	Slow (times/second)	Fast (times/second)
AC V (V or mV)	5	10/20/40
DC V (V or mV)	5	10/20/40
$\Omega$	5	10/20/40
Diode	5	10/20/40
Auto-diode	1	-
Capacitance	1 (<1 mF)	-
DC mA/ $\mu$ A	5	10/20/40
AC mA/ $\mu$ A	5	10/20/40
Temperature	5	10/20/40
Frequency	1 (>10 Hz)	-

[1] The tester has a built in combination filter for data update rate.

[2] The CMRR and NMRR are specified based on five times the data update rate.

## **5 Characteristics and Specifications**

### Electrical Specifications

**THIS PAGE HAS BEEN INTENTIONALLY LEFT BLANK.**

**www.agilent.com**

**Contact us**

To obtain service, warranty, or technical assistance, contact us at the following phone or fax numbers:

United States:

(tel) 800 829 4444 (fax) 800 829 4433

Canada:

(tel) 877 894 4414 (fax) 800 746 4866

China:

(tel) 800 810 0189 (fax) 800 820 2816

Europe:

(tel) 31 20 547 2111

Japan:

(tel) (81) 426 56 7832 (fax) (81) 426 56 7840

Korea:

(tel) (080) 769 0800 (fax) (080) 769 0900

Latin America:

(tel) (305) 269 7500

Taiwan:

(tel) 0800 047 866 (fax) 0800 286 331

Other Asia Pacific Countries:

(tel) (65) 6375 8100 (fax) (65) 6755 0042

Or visit the Agilent World Wide Web at:

[www.agilent.com/find/assist](http://www.agilent.com/find/assist)

Product specifications and descriptions in this document are subject to change without notice. Always refer to the English version on the Agilent website for the latest revision.

© Agilent Technologies, Inc. 2014

Third Edition, June 26, 2014  
U1461-90003



**Agilent Technologies**